



HOSE MASTER

CORRUGATED METAL HOSE & ASSEMBLIES



WHEN TO USE CORRUGATED METAL HOSE

There are many different types of hose available on the market, including metal, rubber, composite, PTFE, and fabric. The decision of which hose type to buy depends on the application for which the hose is being used. Generally, there are eight factors that should alert you to consider using metal hose:

1. TEMPERATURE EXTREMES

If either the temperature of the media going through the hose or the surrounding atmospheric temperature is very cold or hot, metal may be the only material that can withstand such temperature extremes.

2. CHEMICAL COMPATIBILITY

Metal hose can handle a wider variety of chemicals than most other hose types. If the hose will be exposed to aggressive chemicals (either internally or externally), metal hose should be considered.

3. PERMEATION CONCERNS

Non-metal hose is susceptible to gas permeation through the hose wall and into the atmosphere. Metal hose, on the other hand, does not allow permeation. If containing the gases inside the hose is important, metal hose may be required.

4. POTENTIAL FOR CATASTROPHIC FAILURE

When a metal hose fails, it usually develops small holes or cracks. Other hose types tend to develop larger cracks or come apart completely. If a sudden hose failure is potentially catastrophic, a metal hose may help minimize the effects of a failure by leaking product at a slower rate.

5. ABRASION AND OVERBENDING CONCERNS

To prevent abrasion and overbending, a metal hose can be used as a protective cover over wires or even other hoses.

6. FIRE SAFETY

Other hose types will melt when exposed to fire, while metal hose maintains its integrity up to 1300° F. (See NAHAD derating chart on page 33)

7. ACHIEVING FULL VACUUM

Under full vacuum, metal hose maintains its shape while other hose types may collapse.

8. FLEXIBILITY IN FITTING CONFIGURATION

Virtually any type of fitting can be attached to metal hose, while other hose types require special shanks and collars.

DESIGNING AN ASSEMBLY

Assembly Components Page 3
 S.T.A.M.P.E.D. Page 3
 Selecting a Hose Page 4
 Proprietary Forming Methods Page 5
 Braiding Process Page 6

HOSE

Hose Performance Chart Pages 7-8
 Annuflex Page 9
 Masterflex Page 10
 Pressureflex HP Page 11
 PressureMax HP® Page 12
 ChemKing® Page 13
 ChlorSafe™ (Chlorine Transfer Assembly) Page 14
 Formaflex Page 15
 Bronzeflex Page 16
 Extraflex Page 17
 Hydrflex Page 18

FITTINGS

Fittings Pages 19-21

LENGTH OF ASSEMBLY

Length Considerations Pages 22-24

FABRICATION AND SERVICES

Fabrication Options Page 25
 Testing Page 26
 Cleaning Page 27
 Packaging Page 27

ACCESSORIES

Guard, Covers, and Documentation Page 28
 Liner Page 29
 Armor/Bend Restrictor Page 29
 Jacket Page 30
 Tracer Page 30

TECHNICAL INFORMATION

Definitions Pages 31-32
 Temperature Derating Page 33
 Velocity Page 33
 Pressure Drop Page 34
 Vibration Page 35
 Do's & Don'ts Page 36
 Thread Allowance Page 36
 Saturated Steam Page 37
 Thermal Expansion of Pipe Page 37
 Specification Sheet Page 38

ABOUT HOSE MASTER

Engineering Page 39
 Service Page 40
 Quality Page 41
 Products Page 42



ASSEMBLY COMPONENTS

In this section, we will discuss the various components that make up a corrugated metal hose assembly, and what information a metal hose fabricator will need in order to make an assembly for your application. If you need assistance determining this information, we have also included an explanation of how to analyze the application and make the appropriate selections.

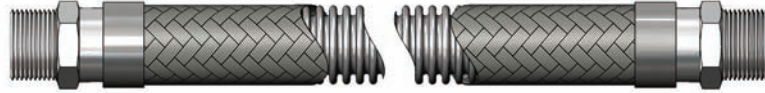

In order to produce an assembly, the fabricator will need answers to the following five questions.

1. **Hose:** (type, alloy, and size): page 4-18
2. **Fittings:** (type, alloy, and size for each end): pages 19-21
3. **Length of the Assembly:** (either overall length or live length): page 22-24
4. **Fabrication Options:** page 25
5. **Accessories:** page 28

If you have the answers to these questions, a metal hose fabricator will be able to make your custom assembly. If you do not have the answers to all five questions, you will need to obtain them. The next section (S.T.A.M.P.E.D.) is designed to help you obtain the information necessary to determine the answers.

S.T.A.M.P.E.D.

To properly design a metal hose assembly for a particular application, the following design parameters must be determined. To help remember them, they have been arranged to form the acronym “S.T.A.M.P.E.D.”

1. **SIZE**
The diameter of the connections to which the assembly will be installed is needed to provide a proper fit. This information is required.
2. **TEMPERATURE**
As the temperature to which the assembly is exposed (internally and externally) increases, the strength of the assembly’s components decreases. Also, the coldest temperature to which the hose will be exposed can affect the assembly procedure and/or fitting materials. If you do not provide this information, it will be assumed that the temperatures are 70° F.
3. **APPLICATION**
This refers to the configuration in which the assembly is installed. This includes both the dimensions of the assembly, as well as the details of any movement that the assembly will experience. This information is necessary to determine assembly length and required flexibility.
4. **MEDIA**
Identify all chemicals to which the assembly will be exposed, both internally and externally. This is important since you must be sure the assembly’s components are chemically compatible with the media going through the hose, as well as the environment in which the hose is to be installed. If no media is given, it will be assumed that both the media and the external environment are compatible with all of the available materials for each component.
5. **PRESSURE**
Identify the internal pressure to which the assembly will be exposed. Also, determine if the pressure is constant or if there are cycles or spikes. This information is important to determine if the assembly is strong enough for the application. If no pressure is given it will be assumed that the pressure is low and there are no pressure surges or spikes.
6. **END FITTINGS**
Identify the necessary end fittings. This is required since fittings for the assembly must be chosen to properly fit the mating connections.
7. **DYNAMICS**
Identify the velocity at which the media will flow through the assembly. Since corrugated metal hose does not have a smooth interior, rapid media flow can create a resonant frequency that will cause the hose to vibrate and prematurely fail. If no velocity is given, it will be assumed that the velocity is not fast enough to affect the assembly’s performance.

When selecting a hose, you must consider three variables: pressure-carrying capability, flexibility, and chemical compatibility.

1. PRESSURE-CARRYING CAPABILITY

The hose must be strong enough to handle the pressures to which it will be exposed. To determine hose pressure capability, consult the catalog for the “Maximum Working Pressure” stated for the hose. The Maximum Working Pressure must be reduced for each of the following circumstances:

- Temperature - As temperature increases, hose working pressure decreases. After you have determined the proper alloy (see “Chemical Compatibility” below) go to the “Derating Factor” table on page 33 in Technical Information and match the alloy of the hose and braid with the highest temperature to which they will be exposed (either internally or externally) to obtain the proper derating factors. Then multiply the hose’s Maximum Working Pressure by the most-limiting temperature derating factor.
- Dynamic Pressure - Pulsating, surge, or shock pressures, like those encountered with quick opening or closing valves, can inflict severe damage on a hose. If your application entails pulsating pressures, the working pressure should be derated by half. If your application entails shock pressures, derate the stated working pressure to 1/6 of its value.

Example:

1" Annuflex hose - T321 stainless steel hose and T304 stainless steel braid @ 500° F with shock pressures.

*Catalog Maximum Working Pressure = 718 psi
Temperature Derating Factor at 500° F. = 0.88; and the
Pressure Derating Factor = 1/6
Maximum Application Working Pressure =
718 psi x 0.88 x 1/6 = 105.31 psi*

2. FLEXIBILITY

Confirm that the hose’s minimum bend radius is less than the bend radius required for the application. Increasing the installed radius of the hose will reduce fatigue on the corrugations, increasing assembly life. Care should also be taken for applications with vibration. Contact Hose Master’s Inside Sales Department if excessive vibration is present. Refer to the Vibration chart on page 35 for additional information.

3. CHEMICAL COMPATIBILITY

You must choose a material for the hose and braid that is compatible with the media being conveyed through the hose, as well as the environment in which the hose is to be installed. When determining chemical compatibility, it is important to know the temperature and concentration of the chemical(s). Although there are many resources to confirm chemical compatibility, two of the industry standards that you may use are the National Association of Corrosion Engineers (NACE) and the Compass Corrosion Guides. You may also contact Hose Master’s Inside Sales Department, which can check these sources for you.



Annular Profile - Independent corrugations, straight and parallel

The manufacturing process of corrugating annular metal hose starts with a stainless steel strip that is rolled and the edges welded together to form a thin-walled, gas-tight tube. Hose Master offers:



High quality steel strip

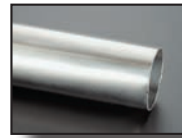

Rolled steel to form a tube with a strong, clean, non-oxidized seam weld

After the tube has been welded, corrugations are formed into the tube to make it flexible. Hose Master uses Hydroforming and Crimp Forming techniques to provide the highest quality annular corrugated metal hose in the industry.

Hydroforming - Hose Master utilizes a proprietary method of hydroforming in which corrugations are formed by expanding a section of stainless steel tube with high pressure water from inside the tube, while simultaneously feeding the tube axially into the process. Hydroforming is a clean, gentle process that enhances flexibility and cycle life, maintains wall thickness, reduces concentrated residual stress, and minimizes work hardening of materials.

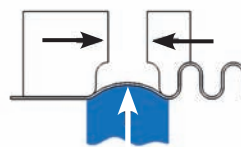

Initial Stage

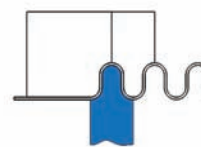

Final Stage

Crimp Forming - Hose Master's proprietary Crimp Forming process is conceptually the inverse of hydroforming, while maintaining the key attributes of product features and benefits. Crimp Forming forms from the exterior by compressing a section of stainless steel tube utilizing a specialized shutter crimp, while simultaneously synchronizing a bi-directional feed of tube axially into the process. This product yields a hose with uniform wall thickness, enhanced flexibility and cycle life, without imparting residual torsional stress common with other manufacturing methods. Starting with 1/4" PressureMax HP, Hose Master uses the Crimp Forming process on items with a relatively large t/d ratio (tube thickness to diameter).

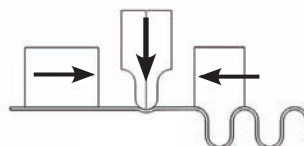

Initial Stage

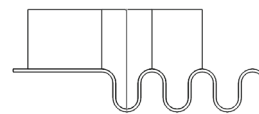

Final Stage



Helical Profile - One continuous corrugation that spirals around the hose

Helical Seam Weld Process - In addition to our line of annular, corrugated hose, Hose Master offers two helical hoses formed from a manufacturing process specially designed to maximize performance without the drawbacks of traditional, mechanically-formed helical hose.

Helical seam welded hoses are made from a stainless steel strip that is formed before welding. Because it is not mechanically formed from a tube, this hose is extremely flexible and does not contain the residual stresses found in traditional mechanically-formed helical hose.



Single-Walled Helical Profile



Double-Walled Helical Profile

Both single-wall and double-walled helical hoses are made by pre-forming the stainless steel strip, overlapping the material, and continuously resistance-welding the seam together.

The single-walled helical hose is formed from a single stainless steel ply, while the double-walled process features two plies of stainless strip for higher pressure ratings.

FEATURES & BENEFITS

- Feature - Hose Master's proprietary forming methods induce minimal residual stress in the hose wall compared to other methods of manufacturing
Benefit - Increased resistance to stress minimizes hose failures and significantly increases cycle life
- Feature - A characteristic of Hose Master's forming processes is a very uniform metal thickness throughout the corrugation profile. Other forming methods can result in significant variations in metal gauge
Benefit - Uniform wall thickness promotes even distribution of strain during flexing, thereby increasing hose longevity
- Feature - Hose Master's proprietary manufacturing methods incorporate three separate tests of the butt-welded hose seam
Benefit - Ensures highest-quality hose and reduces premature product failure
- Feature - Hose Master's forming processes minimize work hardening of the alloy during the corrugating process
Benefit - Results in a more flexible hose and maintains proper alloy yield strength
- Feature - Highest technology equipment combined with skilled workmanship allow the use of lighter gauge metals.
Benefit - Allows for proper wall thickness, maximizing cycle life and flexibility

BRAIDING PROCESS

To give corrugated hose the ability to withstand pressure, stainless steel wire is braided over the hose. Hoses may be single braided (one layer of braid) or double braided (two layers of braid) to achieve even greater working pressures. Braided braid is used on large-diameter hose.

Designing the proper braid for each type of corrugated hose requires sophisticated engineering to maintain the proper balance between the braid strength and the hose's flexibility. Hose Master's braid packages offer several advantages:

1. High Percentage Braid Coverage - Hose Master flexible hose has the highest percentage of braid coverage, yielding better cycle life and protection against damage to the hose.
2. Machine Braided Hose - Hose Master weaves the braid directly onto the hose, ensuring that the braid fits tightly against the hose, preventing potential hose deformation or squirm. Machine braided hose also offers repeatable performance and longer cycle life.

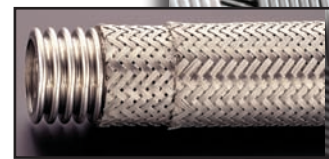

HOSE PERFORMANCE CHART

HOSE TYPE	Number of Braids	Inside Diameter (in.)																	
		1/4		5/16		3/8		1/2		5/8		3/4		1		1 1/4		1 1/2	
		Working Pressure (psi)	Dynamic Bend Radius (in.)	Working Pressure (psi)	Dynamic Bend Radius (in.)	Working Pressure (psi)	Dynamic Bend Radius (in.)	Working Pressure (psi)	Dynamic Bend Radius (in.)	Working Pressure (psi)	Dynamic Bend Radius (in.)	Working Pressure (psi)	Dynamic Bend Radius (in.)	Working Pressure (psi)	Dynamic Bend Radius (in.)	Working Pressure (psi)	Dynamic Bend Radius (in.)	Working Pressure (psi)	Dynamic Bend Radius (in.)
ANNUFLEX Standard Product T321, T316L, T304L See page 9	0	90		n/a	n/a	70		70		57		43		43		43		28	
	1	1800	4.5	n/a	n/a	1558	5.0	1186	5.5	1205	7.0	898	8.0	718	9.0	645	10.0	531	11.0
	2	2700				2336		1779		1808		1347		1077		968		797	
MASTERFLEX Most Flexible T321, T316L, T304L See page 10	0	90		n/a	n/a	70		70		57		43		43		43		28	
	1	1800	3.7	n/a	n/a	1558	4.0	1186	4.4	1205	5.6	898	6.4	718	7.1	645	7.9	531	8.7
	2	2700				2336		1779		1808		1347		1077		968		797	
PRESSUREFLEX HP High Pressure T321 & T316L See page 11	0	450		n/a	n/a	400		400		n/a		220		190		200		90	
	1	3000	5.5	n/a	n/a	3300	8.5	2400	10.0	n/a	n/a	1100	8.0	1000	9.0	900	12.0	750	13.0
	2	4000				n/a	n/a	3200				1650		1400		1350		1200	
PRESSUREMAX HP® Ultra-High Pressure T321 & T316L See page 12	0	500		n/a	n/a	400		200		n/a		250	4.5	180	7.0	190	9.5	110	11.5
	1	5000		n/a	n/a	3500		2700		n/a		2650	10.0	2500	11.0	1775	12.5	1450	13.0
	2	6000	4.5	n/a	n/a	5000	7.0	4500	8.0	n/a	n/a	3600	10.0	3000	11.0	2600	12.5	2200	13.0
	3	n/a				n/a	n/a	n/a				n/a	n/a	n/a	n/a	3000	14.0	n/a	n/a
4	n/a				n/a	n/a	n/a				n/a	n/a	n/a	n/a	n/a	n/a	n/a	n/a	
CHEMKING® Chemical Resistance 276 See page 13	0			n/a	n/a	n/a		70		n/a		43		43		n/a		28	
	1	n/a	n/a	n/a	n/a	n/a	n/a	1186	5.5	n/a	n/a	898	8.0	718	9.0	n/a	n/a	531	11.0
	2							1779				1347		1077				797	
FORMAFLEX Stay-Put Application T321, T316L See page 15	0	90		n/a	n/a	70		70		57		43		43		43		28	
	1	900	n/a	n/a	n/a	800	n/a	665	n/a	500	n/a	380	n/a	355	n/a	280	n/a	264	n/a
	2	n/a				n/a		n/a		n/a		n/a		n/a		n/a		n/a	
BRONZEFLEX Bronze Alloy See page 16	0			n/a	n/a	60		50		n/a		30		26		16		15	
	1	n/a	n/a	n/a	n/a	704	6.0	566	7.0	n/a	n/a	468	8.0	334	10.0	306	12.0	297	13.5
	2					936		753				622		444		407		395	
EXTRAFLEX Helical/Flexible T321 See page 17	0	71		43	2.4	36		28		28		14		11		9		7	
	1	1778	2.2	1422	1991	1138	2.8	910	3.1	910	3.9	711	5.1	569	6.3	455	7.9	356	9.4
	2	2489				1707		1422		1422		1138		910		711		569	
HYDRAFLEX Helical/High-Pressure T316L See page 18	0	n/a		n/a	5.1	n/a		n/a		n/a		n/a		n/a		n/a		n/a	
	1	4600	5.0	4000	4800	3800	5.5	2600	5.7	2400	6.1	2000	6.5	1500	7.9	1100	9.4	1000	12.2
	2	5800				4000		3700		2700		2200		2000		1600		1500	

Product specifications are subject to change without notice.

HOSE PERFORMANCE CHART

HOSE TYPE	Number of Braids	Inside Diameter (in.)																	
		2		2 1/2		3		4		5		6		8		10		12	
		Working Pressure (psi)	Dynamic Bend Radius (in.)	Working Pressure (psi)	Dynamic Bend Radius (in.)	Working Pressure (psi)	Dynamic Bend Radius (in.)	Working Pressure (psi)	Dynamic Bend Radius (in.)	Working Pressure (psi)	Dynamic Bend Radius (in.)	Working Pressure (psi)	Dynamic Bend Radius (in.)	Working Pressure (psi)	Dynamic Bend Radius (in.)	Working Pressure (psi)	Dynamic Bend Radius (in.)	Working Pressure (psi)	Dynamic Bend Radius (in.)
ANNUFLEX Standard Product T321, T316L, T304L See page 9	0	14		14		14		14		14		11		3		4		3	
	1	449	13.0	417	16.0	346	18.0	299	22.0	275	28.0	210	32.0	250	29.0	175	34.0	185	44.0
	2	674		626		519		448		412		315		360		310		325	
MASTERFLEX Most Flexible T321, T316L, T304L See page 10	0	14		14		14		14		14		11							
	1	449	10.3	417	12.8	346	14.5	299	17.4	275	21.9	210	25.0	n/a	n/a	n/a	n/a	n/a	n/a
	2	674		626		519		448		412		315							
PRESSUREFLEX HP High Pressure T321 & T316L See page 11	0	105		46		36		23		28		23							
	1	800	15.0	575	17.0	550	20.0	425	25.0	331	34.0	285	40.0	n/a	n/a	n/a	n/a	n/a	n/a
	2	1150		900		800		575		n/a		n/a							
PRESSUREMAX HP® Ultra-High Pressure T321 & T316L See page 12	0	100	12.0	46	14.5	36	16.0	23	19.0										
	1	1100	14.0	700	16.0	600	20.0	525	26.0										
	2	1675	14.0	1050	16.0	900	20.0	875	26.0	n/a	n/a	n/a	n/a	n/a	n/a	n/a	n/a	n/a	n/a
	3	n/a	n/a	n/a	n/a	1200	75.0	1200	n/a										
CHEMKING® Chemical Resistance 276 See page 13	0	14				14		14		14		11							
	1	449	13.0	n/a	n/a	346	18.0	299	22.0	275	28.0	210	32.0	n/a	n/a	n/a	n/a	n/a	n/a
	2	674				519		448		412		315							
FORMAFLEX Stay-Put Application T321, T316L See page 15	0	14																	
	1	221	n/a	n/a	n/a	n/a	n/a	n/a	n/a	n/a	n/a	n/a	n/a	n/a	n/a	n/a	n/a	n/a	n/a
	2	n/a																	
BRONZEFLEX Bronze Alloy See page 16	0	10		8		5													
	1	210	17.0	194	22.0	166	24.0	n/a	n/a	n/a	n/a	n/a	n/a	n/a	n/a	n/a	n/a	n/a	n/a
	2	279		258		221													
EXTRAFLEX Helical/Flexible T321 See page 17	0	6																	
	1	284	11.0	n/a	n/a	n/a	n/a	n/a	n/a	n/a	n/a	n/a	n/a	n/a	n/a	n/a	n/a	n/a	n/a
	2	455																	
HYDRAFLEX Helical/High-Pressure T316L See page 18	0	n/a																	
	1	750	14.6	n/a	n/a	n/a	n/a	n/a	n/a	n/a	n/a	n/a	n/a	n/a	n/a	n/a	n/a	n/a	n/a
	2	1100																	

Product specifications are subject to change without notice.

ANNUFLEX is the foundation of Hose Master's extensive line of annular products. Proprietary manufacturing processes produce a hose with minimal residual stress, uniform wall thickness throughout the corrugations, and minimal work hardening. These processes create a very flexible, long-lasting corrugated metal hose.



Explanation of Annuflex Part Numbers
 AF _____ 7 _____
 Material Code Braid Code

Material Codes
 4 - T321 Stainless Steel
 5 - T316L Stainless Steel
 7 - T304L Stainless Steel

Braid Codes
 00 - Unbraided
 50 - T304 Single Braid
 55 - T304 Double Braid
 T316 Braid available upon request

Example: AF4750 = T321 stainless steel, annular corrugated metal hose with a single T304 stainless steel braid

Inside Diameter (in.)	Number of Braids (#)	Outside Diameter (in.)	Static Minimum Bend Radius (in.)	Dynamic Minimum Bend Radius (in.)	Maximum Working Pressure (psi)	Burst Pressure (psi)	Weight Per Foot (lbs.)
1/4	0	0.41	1.0	4.5	90	n/a	0.04
	1	0.47			1800	7233	0.11
	2	0.53			2700	9100	0.18
3/8	0	0.65	1.2	5.0	70	n/a	0.10
	1	0.71			1558	6230	0.20
	2	0.77			2336	9345	0.30
1/2	0	0.77	1.5	5.5	70	n/a	0.11
	1	0.83			1186	4743	0.22
	2	0.89			1779	7115	0.33
5/8	0	0.96	1.8	7.0	57	n/a	0.17
	1	1.02			1205	4820	0.33
	2	1.08			1808	7230	0.49
3/4	0	1.16	2.1	8.0	43	n/a	0.19
	1	1.22			898	3591	0.37
	2	1.28			1347	5387	0.55
1	0	1.47	2.7	9.0	43	n/a	0.26
	1	1.53			718	2872	0.50
	2	1.59			1077	4308	0.74
1 1/4	0	1.75	3.1	10.0	43	n/a	0.29
	1	1.83			645	2581	0.61
	2	1.91			968	3872	0.93
1 1/2	0	2.08	3.9	11.0	28	n/a	0.47
	1	2.16			531	2125	0.85
	2	2.24			797	3188	1.23
2	0	2.61	5.1	13.0	14	n/a	0.59
	1	2.69			449	1797	1.11
	2	2.77			674	2696	1.63
2 1/2	0	3.40	6.8	16.0	14	n/a	0.84
	1	3.50			417	1669	1.64
	2	3.60			626	2504	2.44
3	0	3.88	7.8	18.0	14	n/a	1.18
	1	3.98			346	1384	2.06
	2	4.08			519	2076	2.94
4	0	4.96	9.8	22.0	14	n/a	1.41
	1	5.06			299	1194	2.69
	2	5.16			448	1791	3.97
5	0	6.00	12.8	28.0	14	n/a	2.18
	1	6.12			275	1099	3.61
	2	6.24			412	1649	5.04
6	0	7.01	14.8	32.0	11	n/a	2.69
	1	7.13			210	839	4.44
	2	7.25			315	1259	6.19
8*	0	9.04	18.0	29.0	3	n/a	4.88
	1	9.32			250	1000	8.21
	2	9.60			360	1446	11.53
10*	0	11.34	21.0	34.0	4	n/a	7.42
	1	11.56			175	700	11.05
	2	11.78			310	1247	14.67
12*	0	13.45	27.0	44.0	3	n/a	11.04
	1	13.73			185	745	16.71
	2	14.00			325	1308	22.38

* 8 inch, 10 inch and 12 inch diameter AF4750 are supplied with braided braid

- The minimum bend radius is measured from the centerline of the hose
- The working pressure decreases with temperature - obtain derating factor on page 33 in Technical Information
- For rapid pressure fluctuations, consult factory

MASTERFLEX is manufactured using the same high quality process used to make Annuflex hose, but the number of corrugations per foot is increased to provide for greater flexibility.



Explanation of Masterflex Part Numbers

AF _____ 5 _____

Material Code Braid Code

Material Codes

4 - T321 Stainless Steel
5 - T316L Stainless Steel
7 - T304L Stainless Steel

Braid Codes

00 - Unbraided
50 - T304 Single Braid
55 - T304 Double Braid
T316 Braid available upon request

Example: AF4550 = T321 stainless steel, annular corrugated metal hose with a single T304 stainless steel braid

Inside Diameter (in.)	Number of Braids (#)	Outside Diameter (in.)	Static Minimum Bend Radius (in.)	Dynamic Minimum Bend Radius (in.)	Maximum Working Pressure (psi)	Burst Pressure (psi)	Weight Per Foot (lbs.)
1/4	0	0.42	0.9	3.7	90	n/a	0.07
	1	0.48			1800	7233	0.14
	2	0.54			2700	9100	0.20
3/8	0	0.65	1.0	4.0	70	n/a	0.15
	1	0.71			1558	6230	0.25
	2	0.77			2336	9345	0.36
1/2	0	0.77	1.2	4.4	70	n/a	0.18
	1	0.83			1186	4743	0.32
	2	0.89			1779	7115	0.47
5/8	0	0.96	1.4	5.6	57	n/a	0.19
	1	1.02			1205	4820	0.37
	2	1.08			1808	7230	0.54
3/4	0	1.16	1.7	6.4	43	n/a	0.31
	1	1.22			898	3591	0.53
	2	1.28			1347	5387	0.74
1	0	1.47	2.1	7.1	43	n/a	0.41
	1	1.53			718	2872	0.76
	2	1.63			1077	4308	1.11
1 1/4	0	1.75	2.5	7.9	43	n/a	0.63
	1	1.83			645	2581	1.00
	2	1.91			968	3872	1.37
1 1/2	0	2.08	3.1	8.7	28	n/a	0.70
	1	2.16			531	2125	1.16
	2	2.24			797	3188	1.63
2	0	2.61	4.0	10.3	14	n/a	0.88
	1	2.69			449	1797	1.44
	2	2.77			674	2696	1.99
2 1/2	0	3.40	5.4	12.8	14	n/a	1.36
	1	3.50			417	1669	2.16
	2	3.60			626	2504	2.96
3	0	3.88	6.3	14.5	14	n/a	1.63
	1	3.98			346	1384	2.50
	2	4.08			519	2076	3.37
4	0	4.96	7.7	17.4	14	n/a	2.53
	1	5.06			299	1194	3.90
	2	5.16			448	1791	5.29
5	0	6.00	10.0	21.9	14	n/a	4.07
	1	6.12			275	1099	5.53
	2	6.24			412	1649	6.99
6	0	7.01	11.6	25.0	11	n/a	4.46
	1	7.13			210	839	6.34
	2	7.25			315	1259	8.22

- The minimum bend radius is measured from the centerline of the hose
- The working pressure decreases with temperature - obtain derating factor on page 33 in Technical Information
- For rapid pressure fluctuations, consult factory

PRESSUREFLEX HP

PRESSUREFLEX HP® is Hose Master's high-pressure, annular corrugated metal hose. Pressureflex HP® is made from heavy-wall stainless steel, and offers flexibility and dependability when higher pressures are a factor.



Explanation of **Pressureflex HP®** Part Numbers

AF HP
Material Code Braid Code

Material Codes

8 - T321 Stainless Steel
 9 - T316L Stainless Steel

Braid Codes

00 - Unbraided
 50 - T304 Single Braid
 55 - T304 Double Braid
 60 - T316 Single Braid
 66 - T316 Double Braid
 70 - T321 Single Braid
 77 - T321 Double Braid

Example: AF8750 = T321 stainless steel, annular corrugated metal hose with a single T304 stainless steel braid

Inside Diameter (in.)	Number of Braids (#)	Outside Diameter (in.)	Static Minimum Bend Radius (in.)	Dynamic Minimum Bend Radius (in.)	Maximum Working Pressure (psi)	Burst Pressure (psi)	Weight Per Foot (lbs.)
1/4	0	0.423	1.0	5.5	450	n/a	0.08
	1	0.483			3000	12000	0.15
	2	0.543			4000	16000	0.22
3/8	0	0.655	1.5	8.5	400	n/a	0.12
	1	0.735			2400	9600	0.31
	2	0.815			3300	14000	0.48
1/2	0	0.774	2.5	10.0	400	n/a	0.24
	1	0.854			2400	9600	0.40
	2	0.934			3200	12800	0.57
3/4	0	1.13	4.0	8.0	220	n/a	0.41
	1	1.19			1100	4430	0.58
	2	1.25			1650	6696	0.76
1	0	1.43	5.0	9.0	190	n/a	0.52
	1	1.49			1000	4187	0.76
	2	1.55			1400	5837	0.99
1 1/4	0	1.74	6.5	12.0	200	n/a	0.76
	1	1.82			900	3758	1.13
	2	1.90			1350	5494	1.50
1 1/2	0	2.10	7.5	13.0	90	n/a	1.13
	1	2.18			750	3070	1.54
	2	2.26			1200	4842	1.96
2	0	2.55	9.0	15.0	105	n/a	1.10
	1	2.68			800	3304	2.29
	2	2.80			1150	4738	3.47
2 1/2	0	3.35	10.5	17.0	46	n/a	1.75
	1	3.48			575	2461	3.05
	2	3.60			900	3857	4.35
3	0	3.67	12.0	20.0	36	n/a	1.92
	1	3.79			550	2252	3.18
	2	3.92			800	3254	4.46
4	0	4.92	9.8	25.0	23	n/a	2.29
	1	5.04			425	1754	4.12
	2	5.16			575	2350	5.98
5*	0	5.96	12.8	34.0	28	n/a	3.03
	1	6.13			331	1324	5.14
6*	0	6.97	14.8	40.0	23	n/a	3.74
	1	7.22			285	1140	6.44

- Some hose material and braid code combinations may be unavailable. Contact Hose Master Customer Service at 800-221-2319 for available combinations of hose material and braid alloys by hose size
- The minimum bend radius is measured from the centerline of the hose
- The working pressure decreases with temperature - obtain derating factor on page 33 in Technical Information
- For rapid pressure fluctuations, consult factory
- * 5 inch and 6 inch diameters are supplied with braided braid

PRESSUREMAX HP® is Hose Master's annular, heavy-wall corrugated metal hose, specifically designed for **ULTRA** high-pressure applications. PressureMax HP® offers superior flexibility and is made from heavy-wall T321 or T316L stainless steel.



Explanation of PressureMax HP® Part Numbers
 AF _____ 5 _____ HP
 Material Code Braid Code

Material Codes Braid Codes
 8 - T321 Stainless Steel 00 - Unbraided
 9 - T316L Stainless Steel 70 - T321 Single Braid
 77 - T321 Double Braid
 7T - T321 Triple Braid
 7Q - T321 Quad Braid

Example: AF8570 = T321 stainless steel, annular corrugated metal hose with a single T321 stainless steel braid

Inside Diameter (in.)	Number of Braids (#)	Outside Diameter (in.)	Static Minimum Bend Radius (in.)	Dynamic Minimum Bend Radius (in.)	Maximum Working Pressure (psi)	Burst Pressure (psi)	Weight Per Foot (lbs.)
1/4	0	0.431	0.5		500	n/a	0.15
	1	0.556	1.5	4.5	5000	20000	0.32
	2	0.681	1.5		6000	24000	0.49
3/8	0	0.670	1.5		400	n/a	0.18
	1	0.795	2.5	7.0	3500	14000	0.46
	2	0.920	2.5		5000	20000	0.77
1/2	0	0.784	2.0		200	n/a	0.43
	1	0.884	3.0	8.0	2700	10800	0.64
	2	0.984	3.0		4500	18000	0.85
3/4	0	1.15	2.5	4.5	250	n/a	0.63
	1	1.28	4.0	10.0	2650	10669	1.09
	2	1.40	4.0	10.0	3600	14521	1.58
1	0	1.45	3.25	7.0	180	n/a	0.84
	1	1.57	5.0	11.0	2500	10000	1.53
	2	1.70	5.0	11.0	3000	12083	2.25
1 1/4	0	1.75	5.0	9.5	190	n/a	1.32
	1	1.88	6.5	12.5	1775	7119	2.09
	2	2.00	6.5	12.5	2600	10400	2.88
	3	2.13	7.0	14.0	3000	12082	3.71
1 1/2	0	2.11	6.0	11.5	110	n/a	1.75
	1	2.23	7.5	13.0	1450	5800	2.64
	2	2.36	7.5	13.0	2200	8892	3.57
2	0	2.57	7.5	12.0	100	n/a	2.04
	1	2.70	9.0	14.0	1100	4415	3.23
	2	2.82	9.0	14.0	1675	6710	4.45
2 1/2	0	3.38	8.0	14.5	46	n/a	2.73
	1	3.51	9.5	16.0	700	2800	4.29
	2	3.63	9.5	16.0	1050	4200	5.59
3	0	3.70	8.5	16.0	36	n/a	3.13
	1	3.83	10.5	20.0	600	2400	4.39
	2	3.95	10.5	20.0	900	3600	5.67
	3	4.08	23.0	75.0	1200	4800	6.99
4	0	4.82	10.0	19.0	23	n/a	5.11
	1	4.94	13.0	26.0	525	2100	6.94
	2	5.07	13.0	26.0	875	3500	8.80
	4	5.32	32.0	96.0	1200	4800	12.62

- Some hose material and braid code combinations may be unavailable. Contact Hose Master Customer Service at 800-221-2319 for available combinations of hose material and braid alloys by hose size
- The minimum bend radius is measured from the centerline of the hose
- The working pressure decreases with temperature - obtain derating factor on page 33 in Technical Information
- For rapid pressure fluctuations, consult factory

CHEMKING® is Hose Master's chemical-resistant, annular corrugated metal hose. Manufactured with a special 276 alloy, ChemKing® offers excellent flexibility and corrosion resistance for many of the most severe applications found in chemical processing.



Explanation of ChemKing® Part Numbers
 AF 67 _____
 Braid Code

Braid Codes

- 00 - Unbraided
- 60 - T316 Single Braid
- 66 - T316 Double Braid
- 20 - C276 Single Braid
- 22 - C276 Double Braid

Example: AF6760 = 276 annular corrugated metal hose with a single T316 stainless steel braid

Inside Diameter (in.)	Number of Braids (#)	Outside Diameter (in.)	Static Minimum Bend Radius (in.)	Dynamic Minimum Bend Radius (in.)	Maximum Working Pressure (psi)	Burst Pressure (psi)	Weight Per Foot (lbs.)
1/2	0	0.77	1.5	5.5	70	n/a	0.11
	1	0.83			1186	4743	0.22
	2	0.89			1779	7115	0.33
3/4	0	1.16	2.1	8.0	43	n/a	0.19
	1	1.22			898	3591	0.37
	2	1.28			1347	5387	0.55
1	0	1.47	2.7	9.0	43	n/a	0.26
	1	1.53			718	2872	0.50
	2	1.59			1077	4308	0.74
1 1/2	0	2.08	3.9	11.0	28	n/a	0.47
	1	2.16			531	2125	0.85
	2	2.24			797	3188	1.23
2	0	2.61	5.1	13.0	14	n/a	0.59
	1	2.69			449	1797	1.11
	2	2.77			674	2696	1.63
3	0	3.88	7.8	18.0	14	n/a	1.18
	1	3.98			346	1384	2.06
	2	4.08			519	2076	2.94
4*	0	4.96	9.8	22.0	14	n/a	1.41
	1	5.06			299	1194	2.47
	2	5.16			448	1791	3.53
5*	0	6.00	12.8	28.0	14	n/a	2.18
	1	6.12			275	1099	3.61
	2	6.24			412	1646	5.04
6*	0	7.01	14.8	32.0	11	n/a	2.69
	1	7.13			210	839	4.44
	2	7.25			315	1259	6.19

* For 4 inch, 5 inch, and 6 inch diameters, consult factory for delivery

- The minimum bend radius is measured from the centerline of the hose
- The working pressure decreases with temperature - obtain derating factor on page 33 in Technical Information
- For rapid pressure fluctuations, consult factory
- Braid is T316 stainless steel or C276 alloy. Monel™ braid is available upon request. When Monel™ braid is used, stated pressure ratings need to be reduced by 0.75. Part numbers for Monel™ braid are AF6780 (single braid) and AF6788 (double braid)

CHLORSAFE™ is Hose Master's 276 alloy, corrugated chlorine-transfer assemblies, designed specifically to meet the demands of this application. With considerations made for both wet and dry chlorine, these assemblies are the safest available. Hose Master's ChlorSafe™ assemblies are manufactured in compliance with the Chlorine Institute Pamphlet 6, Appendix A, latest edition.



Explanation of ChlorSafe™ Part Numbers
 AF 67 _____
 Braid Code

Braid Codes
 20 - C276 Single Braid
 22 - C276 Double Braid

Example: AF6720 = C276 annular corrugated metal hose with a single C276 braid

Inside Diameter (in.)	Number of Braids (#)	Outside Diameter (in.)	Dynamic Minimum Bend Radius (in.)	Maximum Working Pressure (psi)	Burst Pressure (psi)
1/2	1	0.83	8.0	500	2500
	2	0.89			
3/4	1	1.22	9.0	375	1875
	2	1.28			
1	1	1.53	10.0	375	1875
	2	1.59			
1 1/2	1	2.16	11.0	375	1875
	2	2.24			
2	1	2.69	13.0	375	1875
	2	2.77			

- The minimum bend radius is measured from the center-line of the hose
- Per Chlorine Institute specifications, pressure ratings represent a 5:1 safety factor
- For pressures in excess of Chlorine Institute standards, please consult the factory

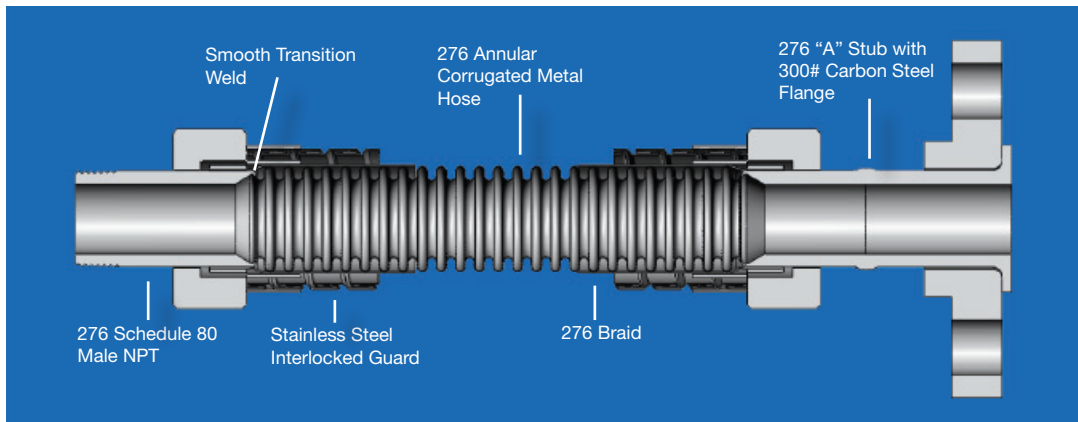

ChlorSafe™ Features:

- Hose Master's proprietary manufacturing processes reduce residual stress and produce the most flexible chlorine-transfer hose available
- ChlorSafe's™ all-metal construction makes it fire-resistant
- Proprietary welding techniques provide a smooth transition from hose to fitting with no gaps or crevices to entrap contaminants
- All welds are argon-purged to eliminate oxidation

ChlorSafe™ Specifications:

- All wetted surfaces and the braid are made from UNS N10276 (referred to as either C276 or 276 alloy) which has the highest chemical resistance rating for both dry and wet chlorine¹
- Every assembly is helium mass spectrometer leak tested to at least 5.0 x 10⁻⁶ std cc/sec
- Each assembly is covered by a stainless steel interlocked metal hose for maximum durability
- All assemblies are strength-tested to twice maximum allowable working pressure

¹ Kenneth M. Pruett, *Chemical Resistance Guide for Metals and Alloys: A Guide to Chemical Resistance of Metals Alloys* (Derby: Compass Publications, 1995), 93.

FORMAFLEX is Hose Master's "stay-put," annular corrugated metal hose. Formaflex is designed to bend and stay in one position, providing a stress-free connection between piping systems.



Explanation of Formaflex Part Numbers
 AF _____ 9 _____
 Material Code Braid Code

Material Codes

4 - T321 Stainless Steel
 5 - T316L Stainless Steel

Braid Codes

00 - Unbraided
 50 - T304 Single Braid

Example: AF4950 = T321 stainless steel, annular corrugated metal hose with a single T304 stainless steel braid

Inside Diameter (in.)	Number of Braids (#)	Outside Diameter (in.)	Static Minimum Bend Radius (in.)	Dynamic Minimum Bend Radius (in.)	Maximum Working Pressure (psi)	Burst Pressure (psi)	Weight Per Foot (lbs.)
1/4	0	0.41	1.0	n/a	90	n/a	0.04
	1	0.47			900	3600	0.11
3/8	0	0.65	1.2	n/a	70	n/a	0.10
	1	0.71			800	3200	0.17
1/2	0	0.77	1.5	n/a	70	n/a	0.11
	1	0.83			665	2660	0.19
5/8	0	0.96	1.8	n/a	57	n/a	0.17
	1	1.02			500	2000	0.26
3/4	0	1.16	2.1	n/a	43	n/a	0.19
	1	1.22			380	1520	0.29
1	0	1.47	2.7	n/a	43	n/a	0.26
	1	1.53			355	1420	0.42
1 1/4	0	1.75	3.1	n/a	43	n/a	0.29
	1	1.81			280	1120	0.47
1 1/2	0	2.08	3.9	n/a	28	n/a	0.47
	1	2.14			264	1056	0.71
2	0	2.61	5.1	n/a	14	n/a	0.59
	1	2.69			221	884	0.90

- The minimum bend radius is measured from the centerline of the hose
- The working pressure decreases with temperature - obtain derating factor on page 33 in Technical Information
- For rapid pressure fluctuations, consult factory

BRONZEFLEX is Hose Master's heavy-duty corrugated hose, designed for use in those applications that specifically require a bronze hose.



Explanation of **Bronzeflex** Part Numbers
BF 11 _____
 Braid Code

Braid Codes
 00 - Unbraided
 10 - Single Bronze Braid
 11 - Double Bronze Braid

Example: AF1110 = Bronze corrugated metal hose with a single bronze braid

Inside Diameter (in.)	Number of Braids (#)	Outside Diameter (in.)	Static Minimum Bend Radius (in.)	Dynamic Minimum Bend Radius (in.)	Maximum Working Pressure (psi)	Burst Pressure (psi)	Weight Per Foot (lbs.)
3/8	0	0.61	2.0	6.0	60	n/a	0.16
	1	0.67			704	2815	0.29
	2	0.73			936	3744	0.42
1/2	0	0.76	2.3	7.0	50	n/a	0.23
	1	0.81			566	2265	0.38
	2	0.87			753	3012	0.53
3/4	0	1.05	2.5	8.0	30	n/a	0.33
	1	1.10			468	1870	0.55
	2	1.16			622	2487	0.77
1	0	1.34	3.0	9.0	26	n/a	0.41
	1	1.42			334	1335	0.68
	2	1.50			444	1776	0.95
1 1/4	0	1.66	3.5	10.0	16	n/a	0.71
	1	1.74			306	1225	1.15
	2	1.82			407	1629	1.59
1 1/2	0	1.89	4.0	10.0	15	n/a	0.93
	1	1.96			297	1187	1.47
	2	2.03			395	1579	2.01
2	0	2.48	6.0	11.0	10	n/a	1.00
	1	2.57			210	840	1.62
	2	2.66			279	1117	2.24
2 1/2	0	3.33	8.5	16.0	8	n/a	1.70
	1	3.45			194	775	2.68
	2	3.57			258	1031	3.66
3	0	3.89	10.0	20.0	5	n/a	2.10
	1	4.01			166	665	3.30
	2	4.13			221	884	4.50

- The minimum bend radius is measured from the centerline of the hose
- The working pressure decreases with temperature - obtain derating factor on page 33 in Technical Information
- For rapid pressure fluctuations, consult factory

EXTRAFLEX is Hose Master's T321 helical seam welded corrugated metal hose, specifically designed to maximize flexibility while maintaining good pressure ratings. The helical design facilitates draining and reduces in-line turbulence.



Explanation of **Extraflex** Part Numbers
EF 90 _____
 Braid Code

Braid Codes
 00 - Unbraided
 50 - T304 Single Braid
 55 - Double Braid
 T316 Braid available upon request

Example: EF9050 = T321 stainless steel, helical corrugated metal hose with a single T304 stainless steel braid

Inside Diameter (in.)	Number of Braids (#)	Outside Diameter (in.)	Static Minimum Bend Radius (in.)	Dynamic Minimum Bend Radius (in.)	Maximum Working Pressure (psi)	Burst Pressure (psi)	Weight Per Foot (lbs.)
1/4	0	0.39	0.4	2.2	71	n/a	0.09
	1	0.45			1778	7112	0.13
	2	0.51			2489	9956	0.19
5/16	0	0.47	0.6	2.4	43	n/a	0.10
	1	0.53			1422	5688	0.18
	2	0.59			1991	7964	0.26
3/8	0	0.55	0.6	2.8	36	n/a	0.11
	1	0.61			1138	4552	0.19
	2	0.67			1707	6828	0.28
1/2	0	0.67	0.8	3.1	28	n/a	0.14
	1	0.73			910	3640	0.26
	2	0.79			1422	5688	0.39
5/8	0	0.85	1.2	3.9	28	n/a	0.19
	1	0.91			910	3640	0.32
	2	0.96			1422	5688	0.46
3/4	0	1.02	1.4	5.1	14	n/a	0.22
	1	1.08			711	2844	0.38
	2	1.18			1138	4552	0.55
1	0	1.22	1.8	6.3	11	n/a	0.24
	1	1.28			569	2276	0.54
	2	1.34			910	3640	0.83
1 1/4	0	1.57	2.4	7.9	9	n/a	0.45
	1	1.65			455	1820	0.76
	2	1.73			711	2844	1.09
1 1/2	0	1.89	3.0	9.4	7	n/a	0.65
	1	1.97			356	1424	1.02
	2	2.05			569	2276	1.40
2	0	2.36	3.5	11.0	6	n/a	0.71
	1	2.44			284	1136	1.22
	2	2.52			455	1820	1.75

- The minimum bend radius is measured from the centerline of the hose
- The working pressure decreases with temperature - obtain derating factor on page 33 in Technical Information
- For rapid pressure fluctuations, consult factory

HYDRAFLEX is Hose Master's T316, double-walled, helical seam welded corrugated metal hose. Specially designed to maintain extreme pressure and flexibility, Hydrflex is self-draining and generates minimal in-line turbulence.



Explanation of **Hydrflex** Part Numbers

HF 34 _____

Braid Code

Braid Codes

50 - T304 Single Braid

55 - Double Braid

T316 Braid available upon request

Example: HF3450 = T316 helical corrugated metal hose with a single T304 stainless steel braid

Inside Diameter (in.)	Number of Braids (#)	Outside Diameter (in.)	Static Minimum Bend Radius (in.)	Dynamic Minimum Bend Radius (in.)	Maximum Working Pressure (psi)	Burst Pressure (psi)	Weight Per Foot (lbs.)
1/4	1	0.52	1.1	5.0	4600	18400	0.21
	2	0.62			5800	23200	0.32
5/16	1	0.62	1.2	5.1	4000	16000	0.29
	2	0.74			4800	19200	0.45
3/8	1	0.70	1.4	5.5	3800	15200	0.36
	2	0.82			4000	16000	0.57
1/2	1	0.82	1.6	5.7	2600	10400	0.43
	2	0.94			3700	14800	0.69
5/8	1	0.97	2.2	6.1	2400	9600	0.51
	2	1.09			2700	10800	0.82
3/4	1	1.19	2.8	6.5	2000	8000	0.64
	2	1.31			2200	8800	1.03
1	1	1.39	3.5	7.9	1500	6000	0.78
	2	1.51			2000	8000	1.25
1 1/4	1	1.75	4.1	9.4	1100	4400	1.15
	2	1.87			1600	6400	1.70
1 1/2	1	2.07	5.1	12.2	1000	4000	1.45
	2	2.19			1500	6000	2.16

- The minimum bend radius is measured from the centerline of the hose
- The working pressure decreases with temperature - obtain derating factor on page 33 in Technical Information
- For rapid pressure fluctuations, consult factory

Metal hose is more versatile than other hose in that virtually any fitting can be attached to metal hose. Other types of hose require special shanks and collars in order to attach fittings. For metal hose, any fitting made from a weldable material can be attached without needing special features. This versatility also means that multiple fittings can be welded together to make custom solutions for difficult applications.

Selecting the proper fittings for an application is largely determined by the mating fittings to which the hose assembly will be attached. Once the mating fittings have been identified, the hose fittings should complement the mating fittings in type, size, and alloy. Even though the selection of the hose fittings is determined by the mating fittings, it is a good idea to confirm that the fittings used in the application are appropriate for the application. Ensure that the fittings are chemically compatible and are able to withstand the pressure and temperatures of both the media and the surrounding environment.



Male Pipe Nipple

Alloys	T304 & T316 Stainless Steel, Carbon Steel, 276
Size Range	1/8" - 12"
Schedules	40, 80



Hex Male

Alloys	T304 & T316 Stainless Steel, Carbon Steel, Brass
Size Range	1/4" - 4"
Schedules	n/a



Grooved-End Fitting

Alloys	T304 & T316 Stainless Steel, Carbon Steel
Size Range	1" - 12"
Schedules	40



LiveLink® Swivel Fitting

Alloys	T304 Stainless Steel
Size Range	1/4" - 2"
Schedules	Consult factory for pressure rating



Female Union (Threaded/Socket Weld)

Alloys	T304 & T316 Stainless Steel, Carbon Steel, Malleable Iron, Brass
Size Range	1/4" - 4"
Class	125#, 150#, 300, 3000# (depending on alloy)



Female Half Coupling (Threaded/Socket Weld)

Alloys	T304 & T316 Stainless Steel, Carbon Steel
Size Range	1/4" - 4"
Class	150#, 3000#



1, 2, or 3 Piece SAE (JIC)

Alloys	T316 Stainless Steel, Carbon Steel, Brass (nut only)
Size Range	1/4" - 2"
Schedules	n/a



45° & 90° SAE (JIC)

Alloys	Stainless Steel, Carbon Steel
Size Range	1/2" - 2"
Schedules	n/a



Sanitary Flange

Alloys	T304 & T316 Stainless Steel
Size Range	1" - 3"
Schedules	n/a



Slip-On Flange

Alloys	T304 & T316 Stainless Steel, Carbon Steel
Size Range	1/2" - 12"
Class	150#, 300#



Plate Flange

Alloys	T304 & T316 Stainless Steel, Carbon Steel
Size Range	1/2" - 12"
Class	150#



Weld Neck Flange

Alloys	T304 & T316 Stainless Steel, Carbon Steel
Size Range	1/2" - 6"
Class	150#, 300#



TTMA Flange

Alloys	T316 Stainless Steel, Carbon Steel
Size Range	2" - 6"
Schedules	n/a



C-Stub with Floating Flange

Alloys	T304 & T316 Stainless Steel
Size Range	1/2" - 10"
Schedules	10



A-Stub with Lap Joint Flange

Alloys	T304 & T316 Stainless Steel, Carbon Steel, 276
Size Range	1/2" - 8"
Schedules	10, 40



TTMA C-Stub Swivel

Alloys	T304 & T316 Stainless Steel
Size Range	4" - 6"
Schedules	10



Part A & Part D (Cam-Lock)

Alloys	T316 Stainless Steel, Brass, Aluminum
Size Range	1/2" - 8"
Schedules	n/a

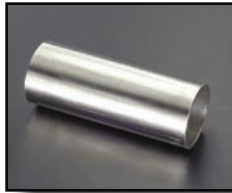

Tube End

Alloys	T304, T316 & T321 Stainless Steel, Carbon Steel
Size Range	1/8" - 12" (seamless or welded)
Schedules	Various



Short & Long Radius Elbows (45° & 90°)

Alloys	T304 & T316 Stainless Steel, Carbon Steel, 276
Size Range	1/4" - 12"
Schedules	Various



Reducer

Alloys	T304 & T316 Stainless Steel, Carbon Steel
Size Range	3/4" - 12"
Schedules	10, 40 (carbon steel)

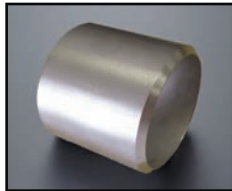

Beveled Pipe End

Alloys	T304 & T316 Stainless Steel, Carbon Steel, 276
Size Range	1/8" - 12"
Schedules	Various



Ground Joint Female

Alloys	Carbon Steel
Size Range	1/2" - 4"
Schedules	n/a



Specialty Gas Nuts

Alloys	Brass
Size Range	A, B, C, & D
Schedules	SAE & BSP

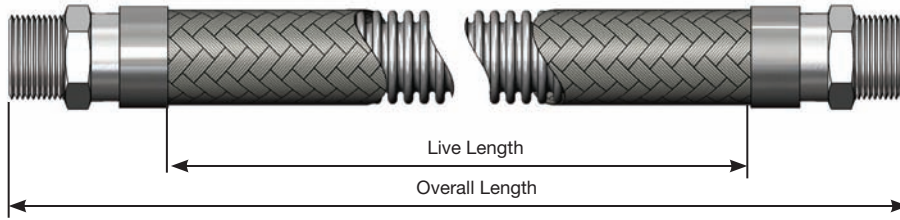

To calculate the proper length of a hose assembly, you need to:

1. **Verify that the installation is properly designed** (refer to Do's & Don'ts on page 36 in Technical Section)
 - Do not torque the hose
 - Do not overbend the hose
 - Do not compress the hose
2. **Calculate the live length of the assembly** - The live length of the assembly is the amount of active (flexible) hose in an assembly; that is, the hose between the braid collars (refer to pages 23-24 for formulas to help calculate live length for a variety of common hose installations).
3. **Calculate the overall length of the assembly** - Overall length is equal to the live length plus the lengths of the braid collars and fittings. When adding fitting lengths, be aware that the points from which measurements should be taken vary for different fitting types. When calculating overall length for assemblies with threaded fittings, remember to account for the length of thread that is lost by threading into the mating connection (refer to Thread Allowance chart on page 36 in the Technical Section).

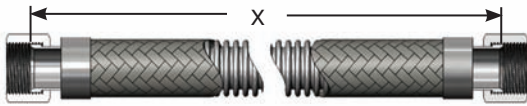

JIC/SAE-type fittings are measured from the seat of the fitting

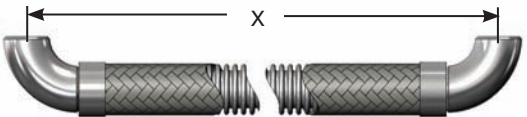

Elbows and other fittings with a radius are measured from the centerline of the fitting

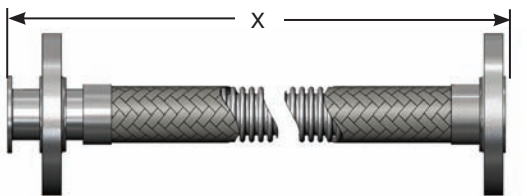

Flanges are measured from the flange face or from the face of the stub end if one is used

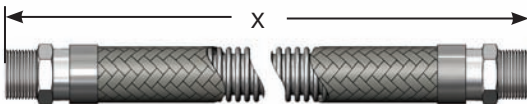

Threaded fittings are measured to the end of the fitting

For assistance in making any calculation or for dimensional information on fittings, please contact Hose Master's Inside Sales Department.

LENGTH CONSIDERATIONS

For the following formulas:

L = Live length of hose (inches)

T = Travel (inches)

S = Hose outside diameter (see product data pages 9-18)

Verify that the installed radius is greater than the stated Minimum Bend Radius for the hose at the required working pressure.

Verify that the centerline of the hose remains in the same plane during cycling to prevent twisting the assembly.

CONSTANT RADIUS TRAVELING LOOP (A-Loop)

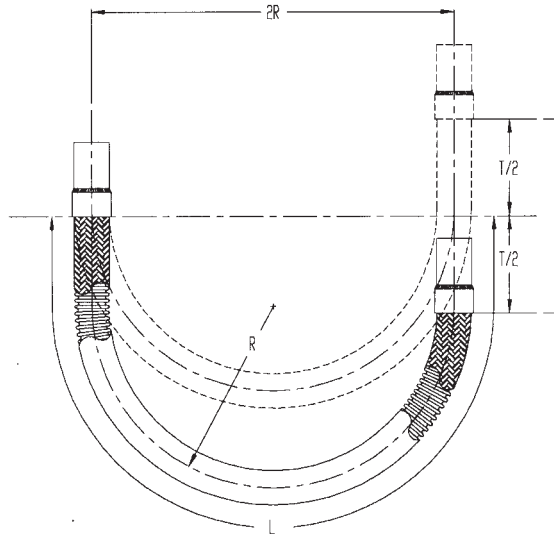

Formula: $L = 4R + 1/2T$

R = Installation radius in this formula

VARIABLE RADIUS TRAVELING LOOP (B-Loop)

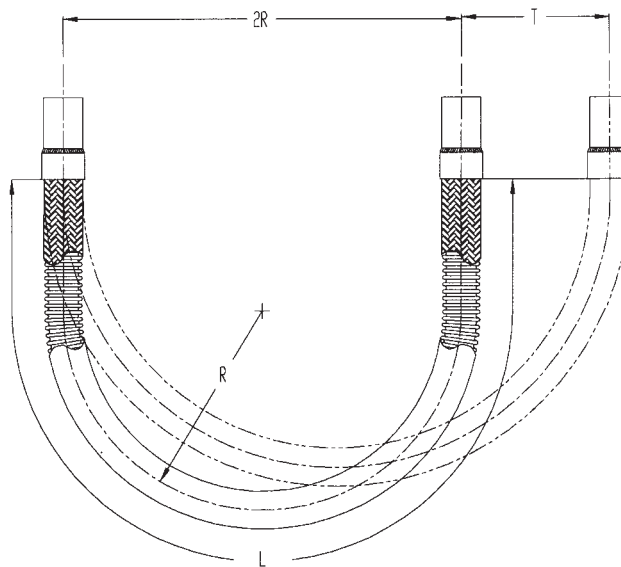

Formula: $L = 4R + 1.57T$

R = Installation radius in this formula

LATERAL OFFSET

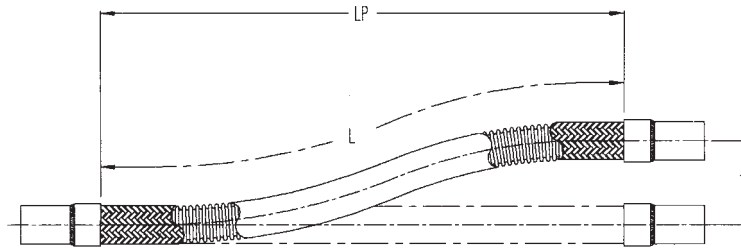

Formula: $L = \sqrt{20R \times T}$ $L_p = \sqrt{L^2 - T^2}$
R = Hose minimum bend radius in this formula

ANGULAR DEFLECTION

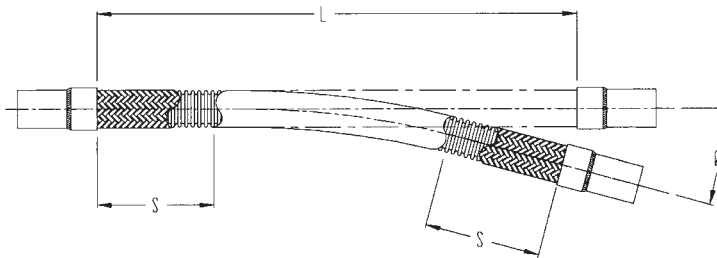

Formula: $L = 2S + (\theta/57.3)R$
R = Hose minimum bend radius in this formula

VERTICAL LOOP WITH MOVEMENT IN TWO DIRECTIONS (Combination Loop)

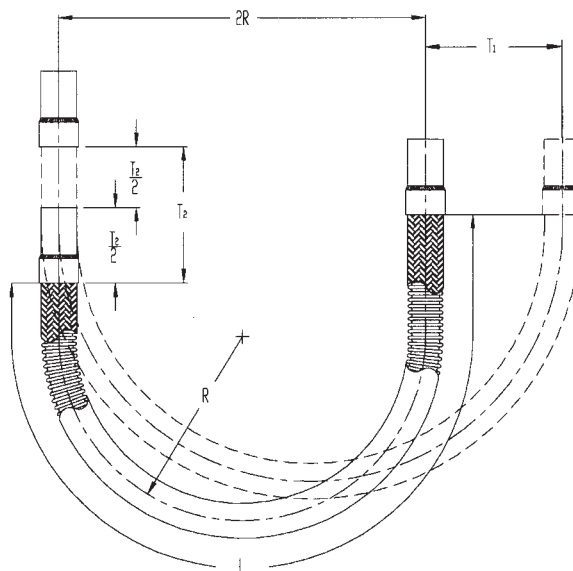

Formula: $L = 4R + 1.57T_1 + (T_2/2)$
R = Hose installation radius in this formula

Corrugated metal hose is used in a very broad spectrum of applications. Just as the hose, fittings, and other assembly parts must be tailored to suit the demands of the service, so too must the methods of joining these components. While standard production joining methods work very well for the majority of service demands, the following extremes may dictate special joining or fabrication techniques:

1. Pressures
2. Temperatures
3. Corrosion
4. Other conditions

Hose Master has developed specialized welding, brazing, joining, and fabrication procedures to assure the integrity and serviceability of metal hose assemblies in even the most extreme applications.

The fabrication options and services to be considered are:

1. Specialized attachment techniques
2. Testing options
3. Additional cleaning requirements
4. Packaging

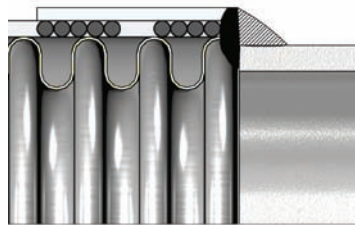

INDUSTRY STANDARD

This method will be used unless another method is specified.

Standard fabrication of an assembly generally consists of:

1. Cutting the hose and braid through a hose corrugation valley
2. Installing a braid collar over each end of the hose
3. Trimming of any excess braid
4. "Cap" welding the hose, braid, and braid collar together
5. Cleaning the cap weld surface
6. Placement and alignment of a fitting on the cap weld
7. "Attachment" welding the fitting to the cap weld
 - Silver brazing is also available, consult factory

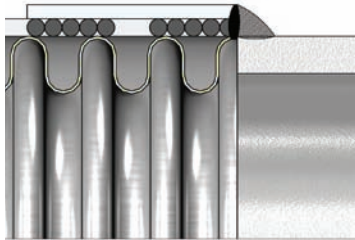

HALF-CORRUGATION

Standard fabrication sometimes leaves a portion of the cut corrugation, or corrugation "lip," just under the base of the fitting. In specialized applications, this residual lip may not be desirable. To prevent any exposed corrugation edges from causing damage, the hose can be specially prepared and welded to remove the lip.

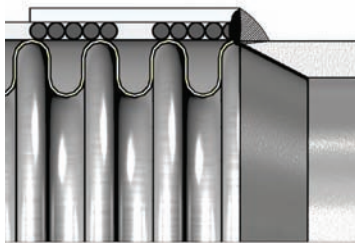

SMOOTH TRANSITION WELD

For applications in which corrosion is a concern, all crevices and fissures must be minimized. Specialized hose and fitting preparation, in conjunction with proprietary welding techniques, is available to provide a full penetration hose-to-fitting weld that is smooth and crevice-free.

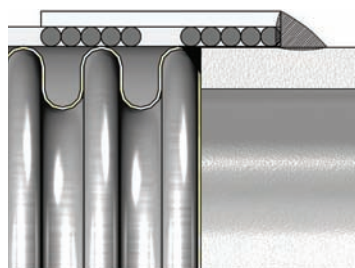

BRAID-OVER CONSTRUCTION

Assemblies operating at the upper limits of their rated working pressure, or in severe service, may benefit from a braid-over construction. The fitting is first expanded and then welded to the unbraided hose. Then the braid is drawn over the end of the hose and welded to the side of the fitting. This technique reduces the amount of heat introduced into the braid wires, nearly eliminates the heat-affected zones of the cap and attachment welds, and maximizes the wire strength. Braid-over construction may also be used for specific high-cycle applications.



STANDARD LEAK TESTING

Every corrugated hose assembly is leak tested prior to shipment. Standard testing consists of pressurizing the assembly with air and then submerging the entire assembly under water. This method is reliable and sufficient for the majority of applications.



HYDROSTATIC TESTING

While the standard test is designed to detect leaks, hydrostatic testing is designed to test the assembly's strength. Testing of an assembly to its full permissible test pressure can be economically and accurately accomplished by filling the assembly with liquid while concurrently evacuating all air. The assembly is then hydrostatically pressurized using high-pressure pumps and the test pressure is maintained for a predetermined period of time.



HIGH-PRESSURE GAS

Testing with air under water, at pressures of up to 2500 psi, is available for specialized applications. For a more sensitive test, the use of gases, such as nitrogen or helium, can be requested.



DYE PENETRANT

Dye penetrant testing is available for both leak and weld bead inspection, in accordance with Hose Master procedures or to customer-specified standards.



HELIUM MASS SPECTROMETER

This is the most sensitive leak detection method generally available. The standard test method is to attach the assembly to a mass spectrometer and generate a very high vacuum in the assembly. The exterior of the assembly is then flooded with helium. The relatively tiny helium atoms penetrate even very small openings and are drawn into the mass spectrometer where they are detected and the leak size is quantified. Helium Mass Spectrometer testing can be modified to satisfy customer or regulatory agency requirements.

Note: Always test an assembly with a medium that has a smaller molecular size than the service required.

CLEANING



Hose Master's proprietary methods of manufacturing corrugated hose yields a very clean product. However, specialized cleaning for specific applications such as Clean and Degrease to CGA G-4.1 and Ultrasonic cleaning for BioPharm applications, are available upon request. Contact Hose Master's Inside Sales Department for details.

PACKAGING



All assemblies are shipped with protectors applied over sealing surfaces, such as threads and flange faces. Spacer bars are installed on all shorter double-flanged assemblies to prevent compression of the assembly during shipping and handling. Special packaging is available to suit customer requirements, including crating, plastic bagging, labeling, and custom fitting protectors.

Metal hose assemblies often require special accessories or components to ensure long service life in severe applications, or to make the assemblies easier to use. There are many accessories that may be specified, including:

- Guards, made from metal and other materials, can be provided to protect an assembly from overbending, abrasion, impact, and thermal damage.
- Jackets and tracer hoses are used with corrugated hose assemblies to keep certain media at elevated or reduced temperatures so that it can be conveyed easily.
- A sacrificial bronze braid can be inserted between the hose and the stainless steel braid to improve cycle life.

One or several accessories can be easily combined with an assembly to more efficiently transport media, protect the assembly, or both.

This is not an exhaustive list of possible accessories, please consult Hose Master's Inside Sales Department for details.

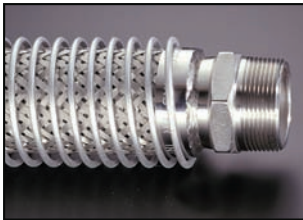

SPRING GUARD

When there is potential for damaging an assembly in service, a guard can be easily installed during fabrication. This type of guard consists of a metal spring that is attached behind the fitting. The style of guard can be tailored to meet the specific application and the type of hose.



PROTECTIVE COVER

If the potential for impact or high-temperature damage is not severe, or if the additional weight and bulk of a full-metal guard is unacceptable, rubber or plastic scuff guards can be installed to protect the corrugated hose and braid.



INSULATING JACKET

If the corrugated hose is to convey high-temperature media, and there is a potential for skin contact, an insulated protective jacket is available. The jacket consists of braided fiberglass insulation, covered and impregnated with silicone rubber that is then installed over the corrugated hose and sealed. The jacket can also be used to insulate the corrugated assembly and either prevent ambient heat from being conveyed to the media or to reduce heat loss.



CERTIFICATIONS

Standard written certifications for materials or inspections can be supplied for corrugated hose or assemblies. Certifications of conformance to specific customer requirements, such as military certifications, PMI (Positive Material Identification), and PED are also available upon request.



TAGGING

A variety of tags and identifications can be affixed to assemblies. These include cardboard, plastic, and metal tags. Serial numbers, application information, assembly performance capabilities, and other customer-specific information can be provided either on tags or permanently engraved onto one or both braid collars.

LINER



An interlocked hose or liner is often installed inside a corrugated hose assembly. The liner commonly serves two purposes while still maintaining the full working pressure of the corrugated hose. The first is to protect the hose corrugations from excessive media velocities. Media speeds can induce resonant vibrations in the corrugations, causing rapid fatigue and subsequent fracturing of the hose wall. The liner provides a relatively smooth surface for the media and, by avoiding the media impacting on the corrugation valleys, reduces the chances of harmonic resonance. The second purpose for a liner is abrasion resistance. Even slightly abrasive media flowing at medium-to-high speeds can cause premature wear of the interior surfaces of the corrugated hose. The liner provides a smooth flow path, as well as a relatively thick layer of abrasion-resistant metal between the media and the corrugated hose. The liner will also help reduce pressure loss due to friction between the media and corrugated hose. Proper fit between the hoses is essential for good performance. Because Hose Master makes both the corrugated hose and liners, a perfect fit is assured.

ARMOR/BEND RESTRICTER

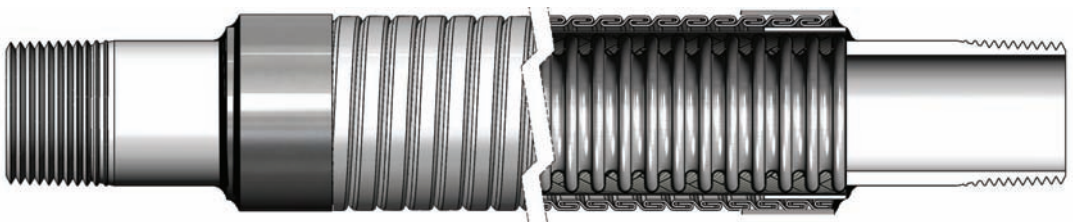

Applications in which the corrugated hose is subjected to external abrasion, molten material splash, or impact damage may require a protective armor or guard along all or a portion of its length. A guard is typically made from interlocked or squarelocked metal hose and is welded to the assembly. Note that the bend restricter has a bend diameter equal-to or greater-than the corrugated hose it is protecting.

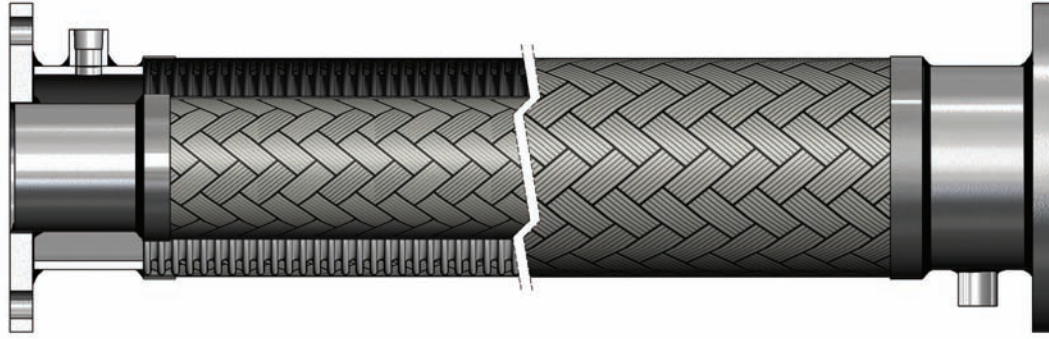

A jacketed assembly consists of a “hose within a hose.” An inner or primary media-conveying hose is enclosed or jacketed by a larger-diameter hose. The hoses are joined at each end by specially designed fittings so that there is no media pathway between the two hoses. Jacketed assemblies are often specified when the primary media must be kept at either an elevated or cryogenic temperature. Steam is often circulated through the jacket hose to keep a viscous material in the inner hose hot and easily conveyed. A vacuum can also be pulled on the jacket hose to insulate cryogenic liquids being conveyed in the inner hose.

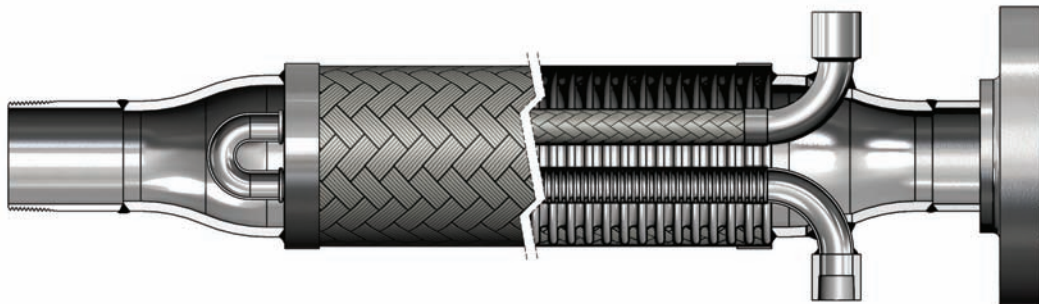

Traced assemblies are similar in concept to jacketed assemblies in that there is an inner, smaller-diameter hose encased by a single, larger-diameter hose. Where jacketed assemblies surround the media with heat or cold, traced assemblies have the media surround the hose containing the heating or cooling element. The tracer, or inner hose, may also be installed in a long “U” shaped loop within the outer hose, with the steam inlet and outlet at the same end of the assembly.

ABRASION

External damage to a hose assembly caused by its being rubbed on a foreign object.

AMBIENT/ATMOSPHERIC CONDITIONS

The surrounding conditions, such as temperature, pressure, and corrosion, to which a hose assembly is exposed.

ANGULAR DEFLECTION

The displacement that occurs when an assembly is bent into a single curve, expressed as an angle.

ANNULAR

Refers to the convolutions on a hose that are a series of complete circles or rings located at right angles to the longitudinal axis of the hose (sometimes referred to as "bellows").

APPLICATION

The service conditions that determine how a metal hose assembly will be used.

ARMOR GUARD OR CASING

Flexible interlocked or squarelocked tubing placed over the entire length of a hose or in short lengths at the end of a metal hose, to protect it from physical damage and to limit the bending radius.

ATTACHMENT

The method of fixing end fittings to flexible metal hose, i.e., welding, brazing, soldering, swaging, bonding, or mechanical.

AXIAL MOVEMENT

Compression or elongation along the longitudinal axis.

BEAMED BRAID

Braid construction where the strands of wire in each carrier are parallel.

BEND RADIUS

The radius of a bend measured to the hose centerline, as recommended by the manufacturer.

BEND RADIUS, DYNAMIC

The radius at which constant or continuous flexing occurs.

BEND RADIUS, MINIMUM

The smallest radius at which a hose can be used.

BEND RADIUS, STATIC

The smallest fixed radius to which a hose can be subjected.

BRAID

A flexible wire sheath surrounding a metal hose that prevents the hose from elongation due to internal pressure. Braid is composed of a number of wires wrapped helically around the hose while at the same time going under and over each other in a basket weave fashion.

BRAID SLEEVE/RING/FERRULE/COLLAR

A ring made from tube or metal strip placed over the ends of a braided hose to contain the braid wires for attachment of fitting and ferrule, and to immobilize heat-affected corrugations.

BRAID WEAR

Motion between the braid and corrugated hose which normally causes wear on the outside diameter of the corrugation and the inside diameter of the braid.

BRAIDED BRAID

In this braid, the strands of wire on each carrier of the braiding machine are braided together, and then braided in normal fashion, hence the term "braided braid".

BRAZING

A process of joining metals using a non-ferrous filler metal with a melting point that is lower than the "parent metals" to be joined.

BUTT WELD

A process in which the edges or ends of metal sections are butted together and joined by welding.

CASING (See ARMOR)

CONTROLLED FLEXING

Occurs when the hose is being flexed regularly, as in the case of connections to moving components. Examples: platen presses and thermal growth in pipe work.

CONVOLUTION/CORRUGATION

The annular or helical flexing member in corrugated or stripwound hose.

CORROSION

The chemical or electro-chemical attack of a media upon a hose assembly.

CYCLE LIFE

The number of cycles completed by an assembly before failure.

CYCLE-MOTION

The movement from normal to extreme position and return.

DEVELOPED LENGTH/OVERALL LENGTH

The length of a hose plus fittings required to meet the conditions of a specific application.

DOG-LEG ASSEMBLY

Two hose assemblies joined by a common elbow.

DUPLEX ASSEMBLY

An assembly consisting of two hose assemblies - one inside the other, and connected at the ends. Also known as "jacketed assemblies."

EROSION

The wearing away of the inside or outside convolutions of a hose caused by the flow of the media conveyed, such as wet steam, abrasive particles, etc.

FATIGUE FAILURE

Failure of the metal structure associated with/due to the flexing of metal hose or bellows.

FERRULE (See BRAID SLEEVE)

FITTING/COUPLING

A loose term applied to the nipple, flange, union, etc., attached to the end of a metal hose.

FLOW RATE

Pertains to a volume of media being conveyed in a given time period, e.g., cubic feet per hour, pounds per second, gallons per minute, etc.

FREQUENCY

The rate of vibration or flexure of a hose in a given time period, e.g. cycles per second (CPS), cycles per minute (CPM), cycles per day (CPD).

HELICAL

Used to describe a type of corrugated hose having one continuous convolution resembling a screw thread.

HELICAL WIRE ARMOR/SPRING GUARD

To provide additional protection against abrasion. Metal hoses can be supplied with an external round or oval section wire spiral.

INSIDE DIAMETER (I.D.)

The diameter inside the hose corrugation.

INTERLOCKED/SQUARELOCKED HOSE

Formed from profiled strip and wound into flexible metal tubing with no subsequent welding, brazing, or soldering. May be made pressure-tight by winding in strands of packing. Refer to Stripwound catalog.

LAP WELD (LW)

Type of weld in which the ends or edges of the metal overlap each other.

LATERAL OFFSET

The perpendicular distance between parallel fitting axes of an assembly.

LINER

Flexible sleeve used to line the inside diameter of hose when conveying a high-velocity media, also prevents erosion.

LIVE LENGTH

The amount of active (flexible) length of hose in an assembly. Does not include the length of fittings and ferrules.

LOOP INSTALLATION

The assembly is installed in a loop or "U" shape and is most often used when frequent and/or large amounts of motion are involved.

MEDIUM, MEDIA

The substance(s) being conveyed through a system.

NOMINAL DIAMETER

Indicates the approximate inside diameter.

OFFSET-LATERAL, PARALLEL

The distance that the ends of a hose assembly are displaced in relation to each other as a result of connecting two misaligned terminations in a system, or intermittent flexure required in a hose application.

OPERATING CONDITIONS

The pressure, temperature, motion, and environment to which a hose assembly is subjected.

OUTSIDE DIAMETER (O.D.)

The external diameter of a metal hose, measured at the top of the corrugation or braiding.

PERCENT OF BRAID COVERAGE

The percent of the surface area of a hose that is covered by braid.

PITCH

The distance between the two peaks of adjacent corrugations or convolutions.

PLY, PLYS

The number of individual thicknesses of metal used in the construction of a wall of the convoluted hose.

PRESSURE

Usually expressed in pounds per square inch (psi).

PRESSURE, BURST

Failure of the hose where the braid fails in tensile, or the hose ruptures, or both, due to the internal pressure applied.

PRESSURE, DEFORMATION

The pressure at which the convolutions of a hose become permanently deformed.

PRESSURE, MAXIMUM ALLOWABLE WORKING

The maximum pressure at which a hose or hose assembly is designed to be used.

PRESSURE, PULSATING

A rapid change in pressure above and below the normal base pressure, usually associated with reciprocating type pumps. This pulsating pressure can cause excessive wear between the braid and the tops of the hose convolutions.

PRESSURE, SHOCK

A sudden increase of pressure in a hydraulic or pneumatic system which produces a shock wave. This shock can cause severe permanent deformation of the hose corrugations, as well as rapid failure due to metal fatigue.

PRESSURE, STATIC

A non-changing, constant pressure.

PRESSURE, WORKING

The pressure, usually internal but sometimes external, imposed on a hose during operating conditions.

RANDOM MOTION

The uncontrolled motion of a metal hose, such as occurs in manual handling.

SAFETY FACTOR

The relationship of working pressure to burst pressure.

SPLICE

A method of joining two sections of hose.

SQUARELOCKED (See INTERLOCKED)

Refer to Stripwound catalog.

SQUIRM

A form of failure in which the hose is deformed into an "S" or "U" bend as the result of excessive internal pressure being applied to unbraided corrugated hose while its ends are restrained, or in a braided corrugated hose which has been axially compressed.

STRESS CORROSION

A form of corrosion in stainless steel normally associated with chlorides.

STRIPWOUND (See INTERLOCKED)

Refer to Stripwound catalog.

TIG WELD/GTAW

The gas tungsten arc welding process sometimes referred to as a "shielded arc" or "heliarc."

TRAVELING LOOP

A general classification of bending wherein the hose is installed in a U-shaped configuration.

TRAVELING LOOP, CLASS A LOOP

An application wherein the radius remains constant and one end of the hose moves parallel to the other end.

TRAVELING LOOP, CLASS B LOOP

A condition wherein a hose is installed in a U-shaped configuration and the ends move perpendicular to each other so as to enlarge or decrease the width of the loop.

TORQUE (TORSION)

A force that produces, or tends to produce, rotation or torsion about the longitudinal axis of a hose assembly while the other end is fixed.

VACUUM

Negative pressure or suction.

VELOCITY

The speed at which the medium flows through the hose.

VELOCITY RESONANCE

The vibration of convolutions due to the buffeting of a high-velocity gas or liquid flow.

VIBRATION

Low-amplitude motion occurring at high frequency.

WELDING

The process of localized joining of two or more metallic components by means of heating their surfaces to a state of fusion, or by fusion with the use of additional filler material.

TEMPERATURE DERATING

To calculate a working pressure derated for elevated temperature, you must first obtain the derating factors for all of the assembly components (i.e. hose, braid, fittings, etc.) from the following chart. Multiply the hose working pressure shown in the catalog by the lowest rating obtained below to determine the derated working pressure. Note: The working pressure of an assembly at elevated temperatures may be affected by fitting type, material, and method of attachment.

Working Pressure Derating Factor													
Temp. in Degrees F	T304 T301*	T304L	T316	T316L	T321	C276	Monel 400 & C22	Inconel 600	Inconel 625	Carbon Steel**	Alum. 3003 H14	Bronze	Copper
70	1.00	1.00	1.00	1.00	1.00	1.00	1.00	1.00	1.00	1.00	1.00	1.00	1.00
100	1.00	1.00	1.00	1.00	1.00	1.00	1.00	1.00	1.00	1.00	1.00	0.97	1.00
200	1.00	1.00	1.00	1.00	1.00	1.00	0.88	1.00	1.00	1.00	1.00	0.89	0.80
300	1.00	1.00	1.00	1.00	1.00	1.00	0.82	1.00	1.00	1.00	0.64	0.83	0.78
400	0.94	0.93	0.97	0.93	1.00	1.00	0.79	1.00	1.00	1.00	0.34	0.78	0.50
500	0.88	0.86	0.90	0.86	0.96	0.99	0.79	1.00	0.97	0.95			0.13
600	0.82	0.81	0.85	0.81	0.91	0.93	0.79	1.00	0.95	0.87			
650	0.81	0.79	0.84	0.79	0.89	0.90	0.79	1.00	0.94	0.85			
700	0.80	0.77	0.82	0.77	0.87	0.88	0.79	1.00	0.93	0.83			
750	0.78	0.75	0.81	0.75	0.86	0.86	0.79	1.00	0.93	0.65			
800	0.76	0.74	0.80	0.74	0.84	0.84	0.79	1.00	0.93	0.54			
850	0.75	0.72	0.79	0.72	0.84	0.83	0.79	0.99	0.93	0.44			
900	0.73	0.71	0.78	0.71	0.83	0.82	0.76	0.95	0.93	0.33			
950	0.72	0.69	0.77	0.69	0.81	0.81	0.71	0.95	0.93	0.23			
1000	0.69	0.67	0.77	0.67	0.81	0.80	0.48	0.42	0.93				
1050	0.61	0.65	0.73	0.65	0.70	0.68		0.27	0.93				
1100	0.49	0.62	0.62	0.61	0.55	0.55		0.20	0.69				
1150	0.39	0.53	0.49	0.52	0.41	0.47			0.57				
1200	0.30	0.38	0.37	0.38	0.32	0.36			0.36				
1250	0.24	0.28	0.28	0.28	0.25	0.29							
1300		0.21	0.21	0.21									

* T301 is not listed in B31.1, but its tensile and yields are identical to T304 per ASM Metals Reference book 3rd Ed. Page 364
 **Do not use for temperatures lower than 32°F

VELOCITY

When gas or liquid being conveyed in a corrugated metal hose exceeds certain limits, resonant vibration can occur. Resonance may cause very rapid failure of the assembly. In those applications where product velocities exceed the limits shown in the chart below, a revision of the assembly design might include:

1. Addition of an interlocked metal hose liner
2. An increase in the corrugated hose I.D.
3. A combination of the above

Velocity in Metal Hose				
Installation Configuration	Maximum Product Velocity (Feet/Second)			
	Unbraided		Braided	
	Dry Gas	Liquid	Dry Gas	Liquid
Straight Run	100	50	150	75
45 Degree Bend	75	40	115	60
90 Degree Bend	50	25	75	40
180 Degree Bend	25	12	38	19

Pressure drop in a piping system is often a concern for the designer. Compared to rigid pipe, there is always a greater pressure drop in corrugated metal hose. The following graphs are offered as aids in estimating pressure drop in corrugated hose conveying water and air. The values derived are approximate and apply only to straight-line installations. Bends and fittings can increase the pressure drop.

Pressure Drop Graph for Water

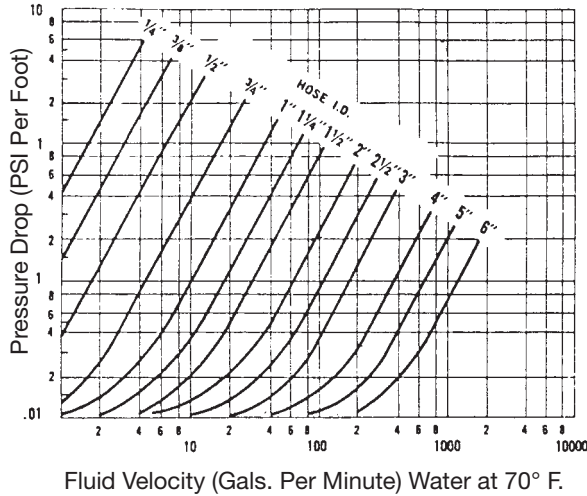

Pressure Drop Graph for Air

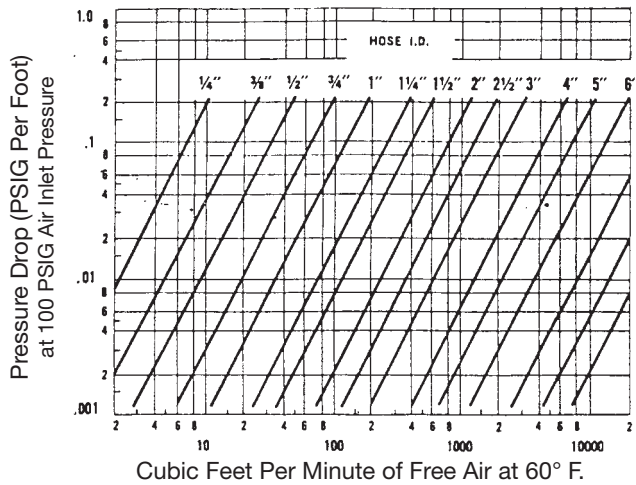

For Air Inlet Pressures Other Than 100 PSIG: P.D. = P.D. @ 100 PSIG $\left(\frac{100 + 14.7}{P + 14.7} \right)$

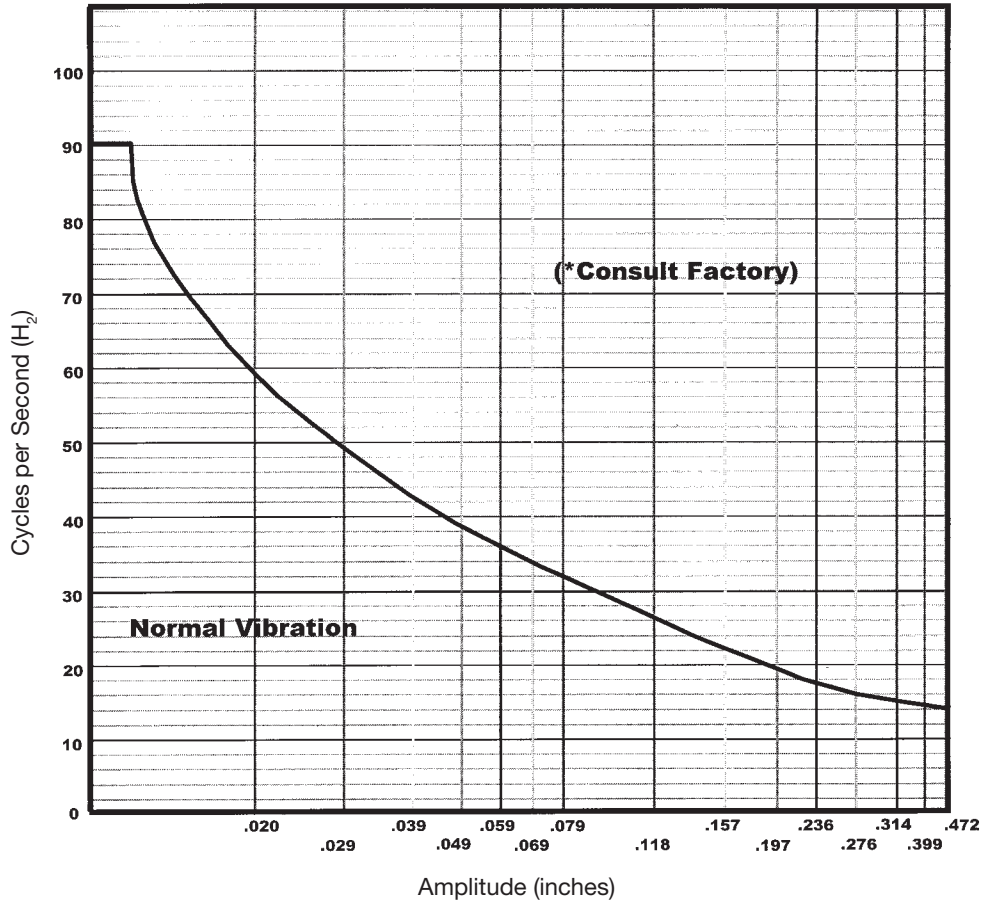

The above graph is representative and should only be used as a guide for estimation purposes. If there are any questions, or your application is near the "Consult Factory" region, please contact Hose Master Inside Sales.

When installing a hose assembly in a vibration application, make sure to install it so the axis of the hose is perpendicular to the direction of the vibration.

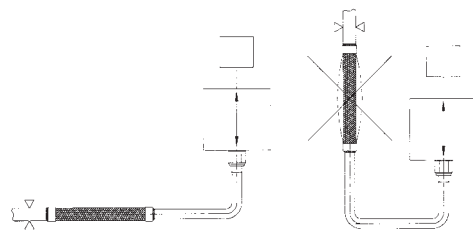

If there is vibration in more than one direction, either install a longer hose bent at 90° or install a "Dog Leg" assembly.

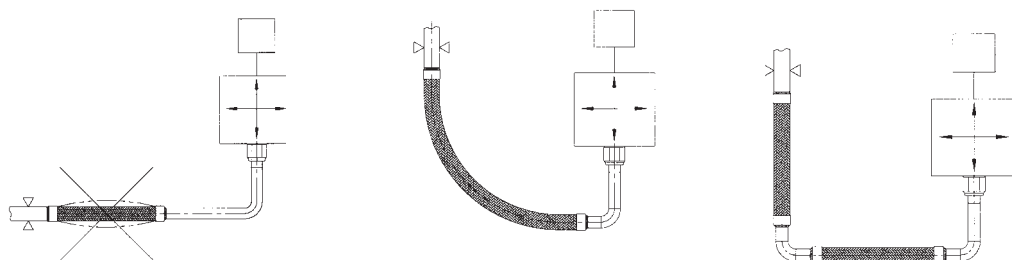

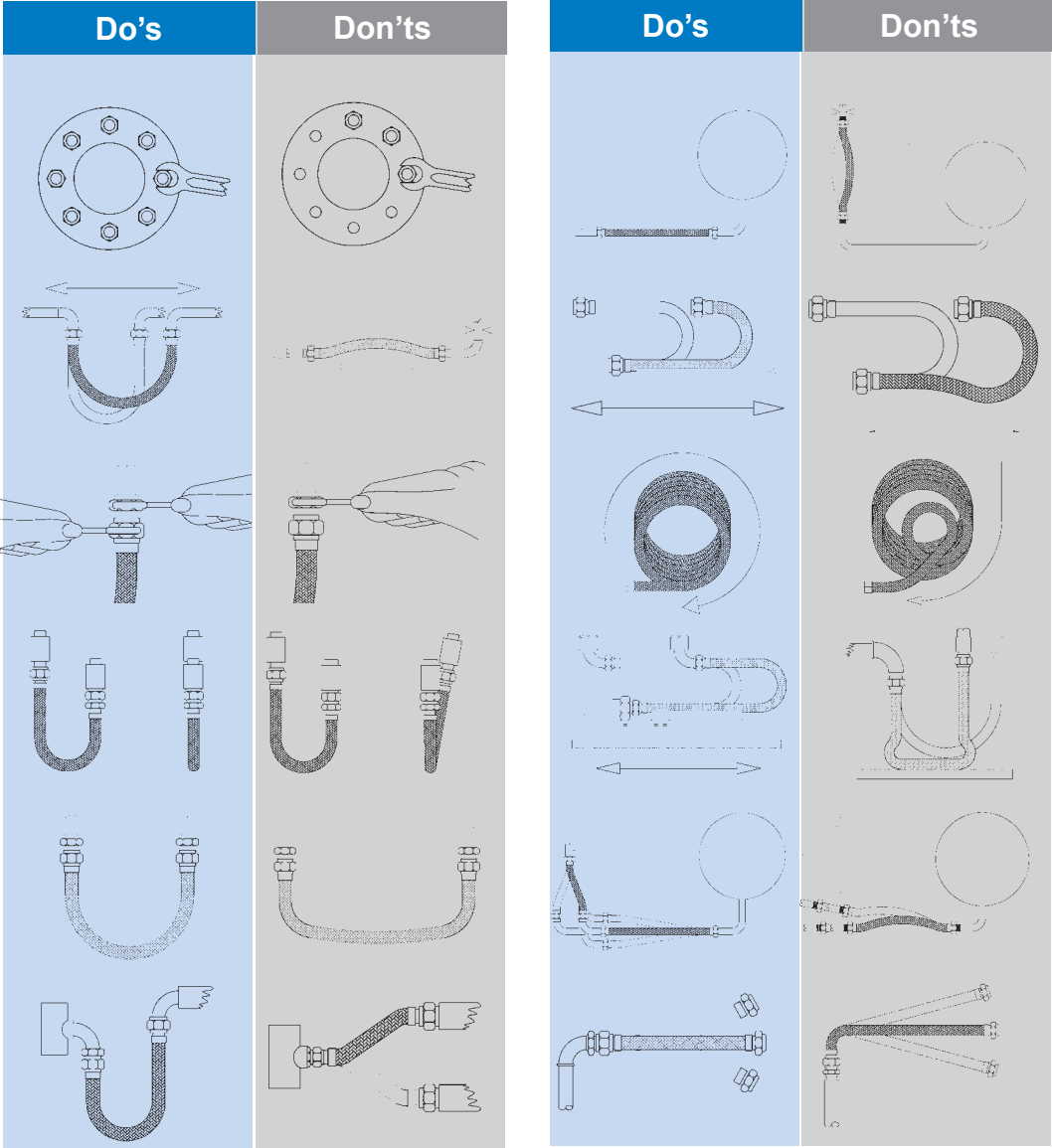

THREAD ALLOWANCE

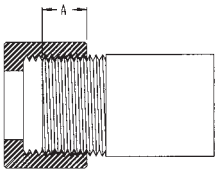

When calculating the overall length (OAL) of a hose assembly that has a pipe thread as one or both end connection(s), consideration must be given to thread engagement. For example, using the chart below, a hose assembly with a 1" male pipe on one end would have 0.66" added to the OAL to compensate for the length of thread that will be engaged during installation.

Nominal Pipe Size (in.)	1/4	3/8	1/2	3/4	1	1 1/4	1 1/2	2	2 1/2	3	4	5	6
Thread Allowance (in.) (Dim "A")	0.40	0.41	0.53	0.55	0.66	0.68	0.68	0.70	0.93	1.01	1.09	1.18	1.20

SATURATED STEAM

Absolute Pressure (PSIA)	Gauge Pressure (PSIG)	Temp. Degrees Fahrenheit	Temp. Degrees Centigrade	Specific Volume (cu. ft. per lb.)
15	0.3	213	101	26.3
20	5.3	228	109	20.1
25	10.3	240	116	16.3
30	15.3	250	121	13.7
35	20.3	259	126	11.9
40	25.3	267	130	10.5
45	30.3	274	134	9.4
50	35.3	281	138	8.5
55	40.3	287	142	7.8
60	45.3	293	145	7.2
65	50.3	298	148	6.7
70	55.3	303	151	6.2
75	60.3	308	153	5.8
80	65.3	312	156	5.5
85	70.3	316	158	5.2
90	75.3	320	160	4.9
95	80.3	324	164	4.7
100	85.3	328	164	4.4
105	90.3	331	166	4.2
110	95.3	335	168	4.0
115	100.3	338	170	3.9
120	105.3	341	172	3.7
125	110.3	344	173	3.6
130	115.3	347	175	3.5
135	120.3	350	177	3.3
140	125.3	353	178	3.2
145	130.3	356	180	3.1
150	135.3	358	181	3.0
160	145.3	364	184	2.8
170	155.3	368	187	2.7

Absolute Pressure (PSIA)	Gauge Pressure (PSIG)	Temp. Degrees Fahrenheit	Temp. Degrees Centigrade	Specific Volume (cu. ft. per lb.)
180	165.3	373	189	2.5
190	175.3	378	192	2.4
200	185.3	382	194	2.3
210	195.3	386	197	2.2
220	205.3	390	199	2.1
230	215.3	394	201	2.0
240	225.3	397	203	1.9
250	235.3	401	205	1.8
260	245.3	404	207	1.8
270	255.3	408	209	1.7
280	265.3	411	211	1.7
290	275.3	414	212	1.6
300	285.3	417	214	1.5
350	335.3	432	222	1.3
400	385.3	445	230	1.2
500	485.3	467	242	0.9
550	535.3	477	247	0.8
600	585.3	486	252	0.8
650	635.3	495	257	0.7
700	685.3	503	262	0.7
750	735.3	511	266	0.6
800	785.3	518	270	0.6
850	835.3	525	274	0.5
900	885.3	532	278	0.5
950	935.3	538	281	0.5
1000	985.3	545	285	0.4
1050	1035.3	551	288	0.4
1100	1085.3	556	291	0.4
1150	1135.3	562	294	0.4
1200	1185.3	567	297	0.4

THERMAL EXPANSION OF PIPE

(ANSI B31.1.0-1967)

Material	F ^a (C°)	Temperature range: 70° F. (21° C.) to (select temperature range)													
		70 (21)	200 (93)	300 (149)	400 (205)	500 (260)	600 (316)	700 (371)	800 (427)	900 (482)	1000 (538)	1100 (593)	1200 (649)	1300 (705)	1400 (760)
Carbon Steel: carbon-moly steel low-chrome steels (through 3% Cr)	A		6.38	6.60	6.82	7.02	7.23	7.44	7.65	7.84	7.97	8.12	8.19	8.28	8.36
	B	0	0.99	1.82	2.70	3.62	4.60	5.63	6.70	7.81	8.89	10.04	11.10	12.22	13.34
Intermediate alloy steels: 5 Cr Mo-9 Cr Mo	A		6.04	6.19	6.34	6.50	6.66	6.80	6.96	7.10	7.22	7.32	7.41	7.49	7.55
	B	0	0.94	1.71	2.50	3.35	4.24	5.14	6.10	7.07	8.06	9.05	10.00	11.06	12.05
Austenitic stainless steels	A		9.34	9.47	9.59	9.70	9.82	9.92	10.05	10.16	10.29	10.39	10.48	10.54	10.60
	B	0	1.46	2.61	3.80	5.01	6.24	7.50	8.80	10.12	11.48	12.84	14.20	15.56	16.92
Straight chromium stainless steels: 12 Cr, 17 Cr, and 27 Cr	A		5.50	5.66	5.81	5.96	6.13	6.26	6.39	6.52	6.63	6.72	6.78	6.85	6.90
	B	0	0.86	1.56	2.30	3.08	3.90	4.73	5.60	6.49	7.40	8.31	9.20	10.11	11.01
25 Cr-20 Ni	A		7.76	7.92	8.08	8.22	8.38	8.52	8.68	8.81	8.92	9.00	9.08	9.12	9.18
	B	0	1.21	2.18	3.20	4.24	5.33	6.44	7.60	8.78	9.95	11.12	12.31	13.46	14.65
Monel 67: Ni-30 Cu	A		7.84	8.02	8.20	8.40	8.58	8.78	8.96	9.16	9.34	9.52	9.70	9.88	10.04
	B	0	1.22	2.21	3.25	4.33	5.46	6.64	7.85	9.12	10.42	11.77	13.15	14.58	16.02
Monel 66: Ni-29 CuAl	A		7.48	7.68	7.90	8.09	8.30	8.50	8.70	8.90	9.10	9.30	9.50	9.70	9.89
	B	0	1.17	2.12	3.13	4.17	5.28	6.43	7.62	8.86	10.16	11.50	13.00	14.32	15.78
Aluminum	A		12.95	13.28	13.60	13.90	14.20								
	B	0	2.00	3.66	5.39	7.17	9.03								
Gray cast iron	A		5.75	5.93	6.10	6.28	6.47	6.65	6.83	7.00	7.19				
	B	0	0.90	1.64	2.42	3.24	4.11	5.03	5.98	6.97	8.02				
Bronze	A		10.03	10.12	10.23	10.32	10.44	10.52	10.62	10.72	10.80	10.90	11.00		
	B	0	1.56	2.79	4.05	5.33	6.64	7.95	9.30	10.68	12.05	13.47	14.92		
Brass	A		9.76	10.00	10.23	10.47	10.69	10.92	11.16	11.40	11.63	11.85	12.09		
	B	0	1.52	2.76	4.05	5.40	6.80	8.26	9.78	11.35	12.98	14.65	16.39		
Wrought iron	A		7.32	7.48	7.61	7.73	7.88	8.01	8.13	8.29	8.39				
	B	0	1.14	2.06	3.01	3.99	5.01	6.06	7.12	8.26	9.36				
Copper-nickel (70/30)	A		8.54	8.71	8.90										
	B	0	1.33	2.40	3.52										

A = mean coefficient of thermal expansion x 10⁶, in/in/°F in going from 70°F. (21° C.) to indicated temperature

B = linear thermal expansion, in/100 ft., going from 70° F. (21° C.) to indicated temperature

Multiply values of A shown by 1.80 to obtain coefficient of expansions in cm/cm/°C.

Multiply values of B shown by 8.33 to obtain linear expansion in cm per 100 m.

Instructions: To place an order or request a quotation, please complete Section I. If you need assistance in specifying an assembly, complete Section II as well as the "End Fittings" portion of Section I. When completed, fax this form to Hose Master at (216) 481-7557 or email it to insidesales@hosemaster.com.

Customer: _____
 Contact: _____ Date: _____
 Phone: _____ Fax: _____ Email: _____

Section I Specification Information

Request Quote: _____ (or) Place Order P.O.# _____
 Quantity: _____ Date Required: _____
 Hose (type and diameter): _____ Length (inches): _____ Live Length / Overall Length
Circle One
 End Fittings (type and size for both ends)
 End #1 Size: _____ Type: _____ Material: _____
 End #2 Size: _____ Type: _____ Material: _____
 Liner Required: _____ Yes _____ No If "Yes," Liner Material: _____
 Special Fabrication: _____
 Accessories: _____

Section II Application Information

Please provide the following information. Be sure that the answers are in the unit of measure stated on the form. If necessary, convert from a different unit of measure. Where appropriate, we have included the assumptions that will be made if an answer is not given.

Application Drawing: (sketch the installation and include all dimensions and motions of hose during application)

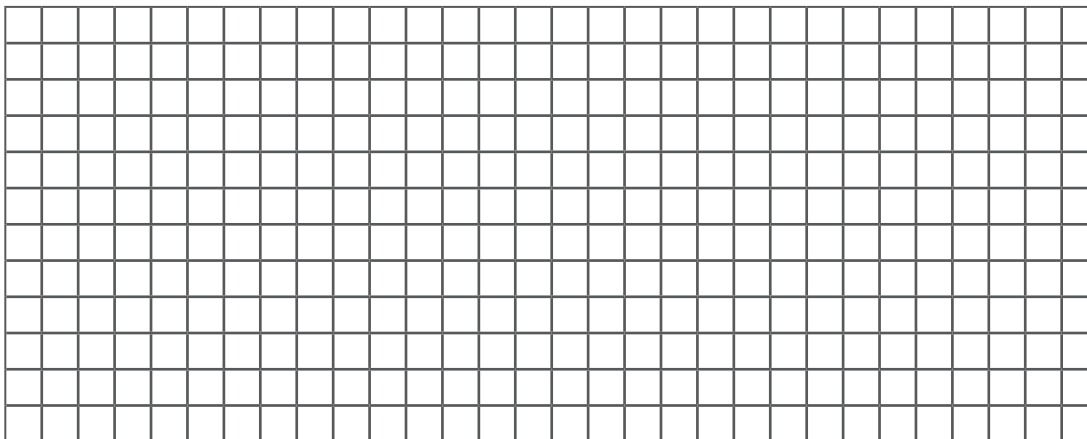

Size (inches): _____ (In the event the fittings or hose have different sizes, include all sizes and show on the application drawing)
 Temperature: Media: Min. _____°F. Max. _____°F. Environment: Min. _____°F. Max. _____°F. (Assumption is 70° F. for all)
 Media: _____ (Assumption is the media is compatible with all available materials)
 Max. Pressure (psi): _____ Fluctuations None / Pulsating / Shock (Assumption is nominal pressure, no fluctuations)
Circle One
 Max. Velocity (feet/second): _____ (Assumption is velocity is too slow to affect performance)
 Type of Motion (From drawing above): Static / Constant / Vibration (Assumption is static)
Circle One

Product Engineering



- Our team of engineers is available to answer questions and provide solutions to the most complex applications
- Available on-site assistance
- Quick turnaround from concept to completion

Machine Design

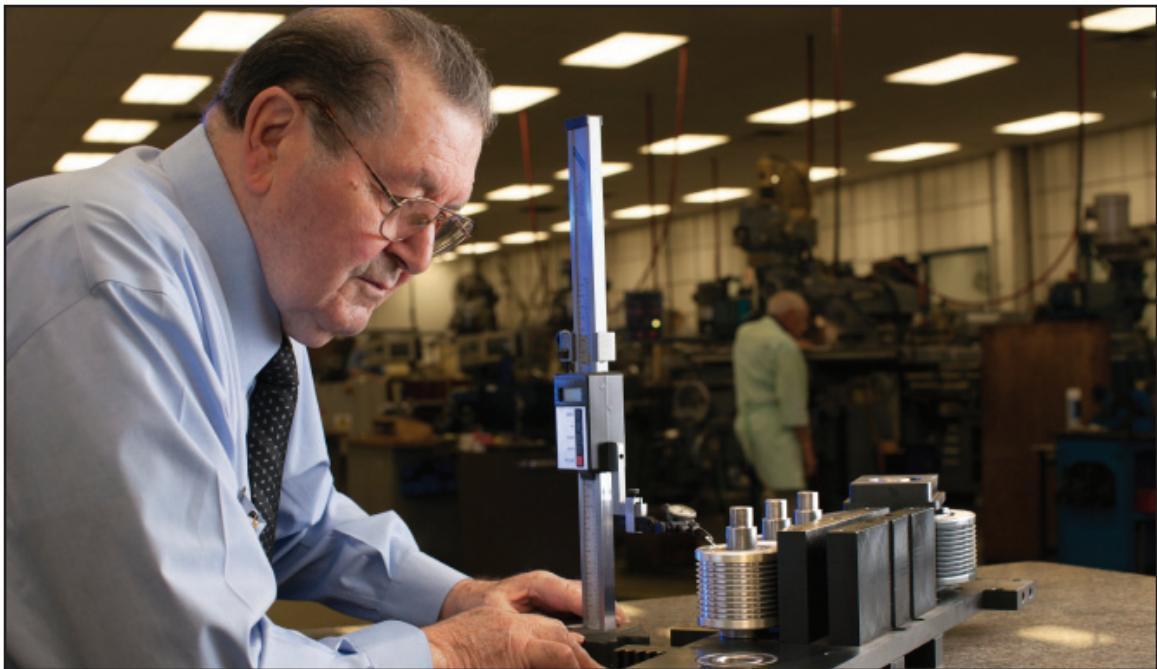

Hose Master designs and manufactures its own products and proprietary production equipment, offering innovative solutions for demanding applications.

Manufacturing, Fabricating, and Stocking Facilities



Cleveland, Ohio



Atlanta, Georgia



Reno, Nevada



Houston, Texas



90+ Welders and large inventories enable us to respond quickly to customer demands

Testing and Certifications

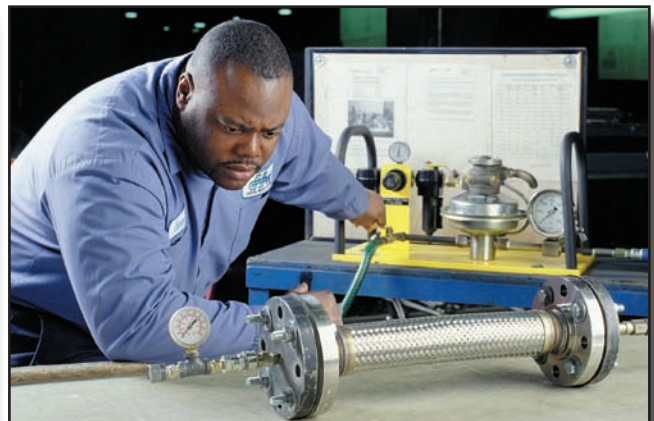

PED
Pressure
Equipment
Directive



ASME IX
Certified Welders



Stripwound Metal Hose and Assemblies



Corrugated Metal Hose and Assemblies



Metal Bellows and Expansion Joints





HOSE MASTER

1233 East 222nd Street • Cleveland, Ohio 44117
(800) 221-2319 • Fax: (216) 481-7557 • www.hosemaster.com
Cleveland • Houston • Atlanta • Reno

ISO 9001
Registered Quality System



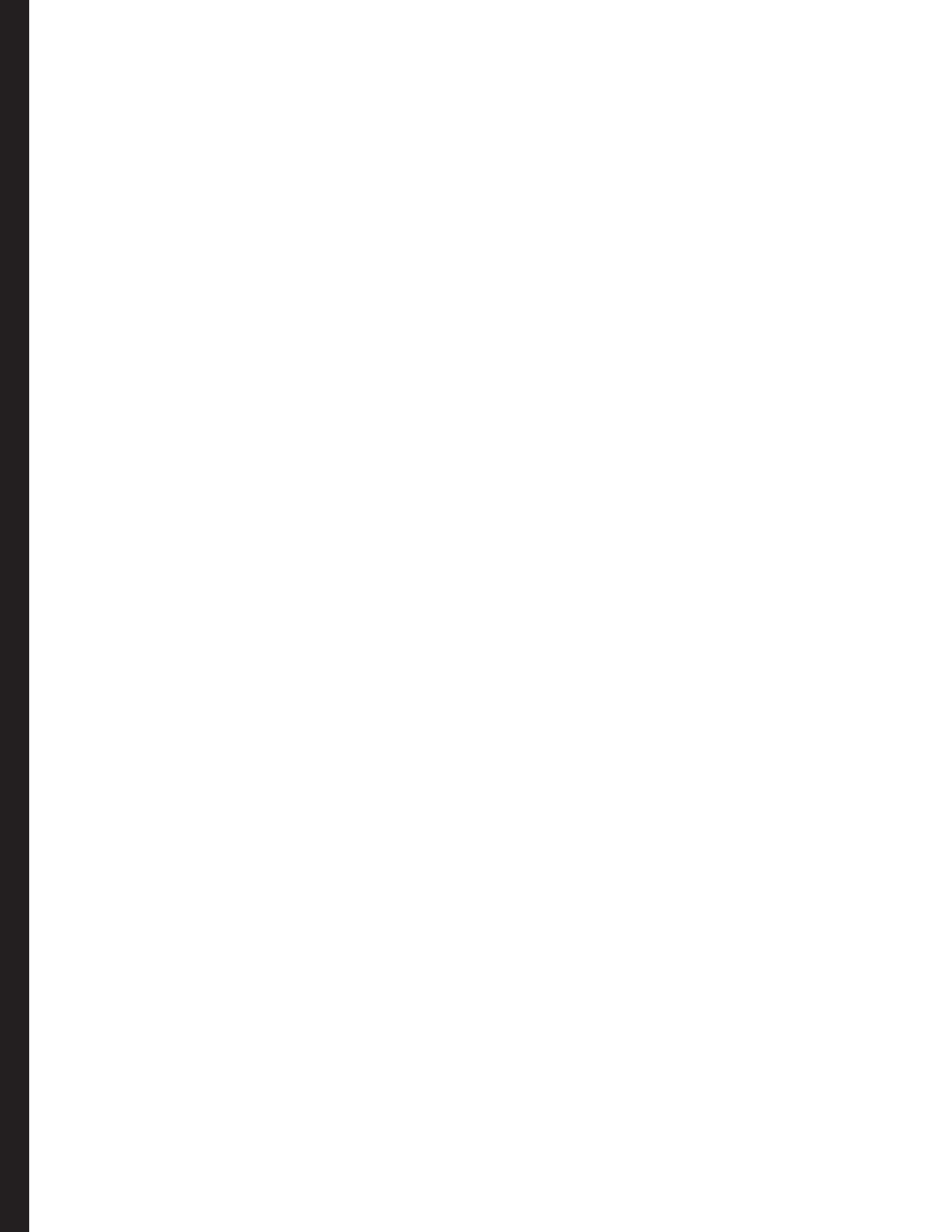



HOSE MASTER

STRIPWOUND METAL HOSE AND ASSEMBLIES



STRIPWOUND METAL HOSE OVERVIEW

Stripwound metal hose is a rugged product made from a strip of steel that is profiled and continuously wound around a mandrel to form a hose. Hose Master's proprietary manufacturing process yields an extremely consistent and balanced profile that maximizes strength and flexibility. Stripwound hose is used as a guard, exhaust hose, and for the transfer of dry bulk materials.

Types of Stripwound Metal Hose Products

Roughbore Interlocked



The strip is formed with legs that interlock to form a hose that is flexible and ideally suited for conveying dry bulk materials, gas exhaust, or used as a protective cover.

Smoothbore Interlocked

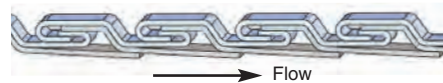

Designed to reduce damage to delicate materials, another steel strip is added inside a roughbore hose to provide a smooth interior surface. Smoothbore hose is also flexible and used for dry bulk conveying.

Packed Interlocked



Packing may be added to interlocked hose to minimize leakage through the hose profile. The most effective packings are made from resilient materials such as elastomers and, to a lesser extent, cotton. Harder materials (stainless steel and copper) are also available if requested.

Torque-Resistant Interlocked



Designed for torque resistance and enhanced sealability, this product resists twisting, unwinding, and strip flare-up after cutting. Torque-resistant hose is manufactured in either roughbore or smoothbore constructions.

Floppy Interlocked



Designed to offer flexibility, strength, and crush-resistance, this product is used for casing or armor of small diameter hose and electrical cables.

Floppy Squarelocked



The strip is formed into square shapes that are locked together. Squarelocked is flexible and is primarily used as a protective covering for wires, fiber optic cables, and other hoses.

Roughbore Interlocked Metal Hose (with or without packing)

Interflex (Standard) Page 3

- General-purpose interlocked metal hose
- Suited for air and exhaust applications
- Also used for transferring a variety of solid materials (not intended for products that could be damaged when being conveyed against a rough surface)

T-Rex™ (Torque-Resistant) Page 4

- Patented torque-resistant design
- Enhanced sealability

Smoothbore Interlocked Metal Hose (with or without packing)

Ultraflex (Standard) Page 5

- Constructed from two strips of metal that form an armor and liner
- Smooth, abrasion-resistant liner
- Suited for pneumatic and dry bulk conveying
- Directional arrow on hose indicates flow direction

T-Rex SB™ (Torque-Resistant) Page 6

- Patented torque-resistant design
- Enhanced sealability

Floppy Metal Hose

FloppyGuard™ (Interlocked) Page 7

- Strong
- Crush-resistant
- Suited for casing or armor for small diameter hose and electrical cable

FloppyGuard SQ™ (Squarelocked) Page 8

- Flexible
- Squarelocked construction
- Suited for shielding on electrical wiring and fiber optic cable

Specialty Metal Hose

Poly-Rex Polygonal Hose..... Page 9

Tar & Asphalt (Heavy-Duty Packed Interlocked)Page 10

- Heavy-weight galvanized interlocked metal hose
- Suited for transferring high-temperature, viscous fluids

Assembly Options and Accessories

FittingsPages 11-12

Assembly Length Page 13

Fabrication Options Page 14

Accessories Page 15

About Hose Master

Service Page 16

Quality Page 17

Products Page 18

INTERFLEX (Roughbore) is a high-quality, general-purpose hose, constructed from a single strip of metal that is profiled and locked onto itself. The interlocked, or overlapping, sections of strip are able to slide back and forth, providing the ability to flex.



INTERFLEX Features

- Balanced interlocked construction
- Durability
- Flexibility
- Service life

INTERFLEX Applications

- High-temperature ducting/hot air blower hose
- Engine exhaust
- Loading and unloading of trailers and rail cars
- Grain vacuum equipment
- Bulk transfer of abrasive materials
- Dust collection equipment
- Outer guard over other hoses to prevent damage, kinking, or as protection from blow-out
- Internal liner in corrugated hose to improve flow velocity and abrasion resistance

INTERFLEX Part Numbers IN *Thickness* *Material*

Thickness Codes

10 - Extra Light Weight
 15 - Light Weight
 18 - Medium Weight
 20 - Medium Weight (AL only)
 25 - Heavy Weight
 30 - Extra Heavy Weight

Material Codes

AL - Aluminum
 GS - Galvanized Steel
 SS - T304 Stainless Steel
 16 - T316 Stainless Steel
 20 - T201 Stainless Steel

Example: IN10SS is made from T304 stainless steel strip .010" thick.

Packing Options

Packing Type	Features	Maximum Temperature
Low-Temp Elastomeric	Max Press & Vacuum	200° F.
High-Temp Elastomeric	Max Press & Vacuum	500° F.
Low-Temp Fiber	Economical	180° F.
High-Temp Fiber	Elevated Temperature	1000° F.
Metal	Extreme Temperature	800° - 1200° F.

INTERFLEX (Roughbore) Hose Specifications

Inside Dia. (in.)	IN 10 _____ (GS,SS)		IN 15 _____ (GS,SS,16,20)		IN 18 _____ (GS,SS,16,20)		IN 25 _____ (GS,SS,20)		IN 30 _____ (GS,SS)		IN 20 AL	
	Weight per Foot (lbs.)	Min. Bend Radius (in.)	Weight per Foot (lbs.)	Min. Bend Radius (in.)	Weight per Foot (lbs.)	Min. Bend Radius (in.)	Weight per Foot (lbs.)	Min. Bend Radius (in.)	Weight per Foot (lbs.)	Min. Bend Radius (in.)	Weight per Foot (lbs.)	Min. Bend Radius (in.)
1.375			0.7	7	0.8	7						
1.5	0.5	6	0.7	6	0.9	6	1.3	7				
2	0.7	8	1.0	8	1.1	8	1.7	9	2.0*	11		
2.5	0.8	10	1.2	10	1.4	10	2.1	11	2.5*	13		
3	1.0	11	1.4	12	1.6	12	2.5	13	2.9	14	0.7	14
3.5	1.1	13	1.6	14	1.9	14	2.8	15	3.4	16	0.8	16
4	1.2	14	1.8	16	2.2	16	3.2	17	3.8	18	0.9	18
4.5	1.4	17	2.0	17	2.4	17	3.6	19	4.3	20	1.0	20
5	1.5	18	2.2	19	2.7	19	4.0	21	4.7	22	1.1	22
6	1.8	21	2.7	23	3.2	23	4.7	25	5.6	26	1.3	26
7			3.1	27	3.7	27	5.5	29	6.5	30	1.5	30
8			3.5	30	4.2	30	6.2	33	7.4	34	1.8	34
9			3.9	34	4.7	34	7.0	37	8.3	38	2.0	38
10			4.4	38	5.2	38	7.7	41	9.2	42	2.2	42
11					5.7	42	8.5	45	10.1	46	2.4	46
12					6.2	45	9.3	49	11.0	50	2.6	50
13					6.7	49	10.0	53	11.9	54	2.8	54
14					7.2	53	10.8	56	12.8	57	3.0	57
15					7.7	56	11.5	60	13.7	61	3.2	61
16					8.2	60	12.3	64	14.6	65	3.4	64

* 2 & 2.5 IN 30 available in Galvanized ONLY • Other diameters are available upon request. • For packed hose add 10% to both weight per foot and minimum bend radius • Minimum bend radius is measured from the centerline of the hose.

T-REX™ (Roughbore) is Hose Master's torque-resistant stripwound metal hose with enhanced sealability. T-Rex™ provides resistance to twisting, unwinding, and metal strip flare-up when cut.

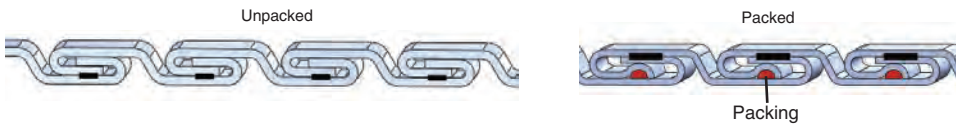

T-REX™ Features

- Torque-resistant
- Leak-resistant
- Same great flexibility as standard interlocked products

T-REX™ Applications

- Dry bulk pneumatic conveying
- Material handling
- Pellet transfer
- Bulk unloading

T-REX™ (Roughbore) Part Numbers

RX [Thickness](#) [Material](#)

Thickness Codes

15 - Light Weight
18 - Medium Weight
25 - Heavy Weight

Material Codes

GS - Galvanized Steel
SS - T304 Stainless Steel
16 - T316 Stainless Steel
20 - T201 Stainless Steel

Example: RX15SS is made from T304 stainless steel strip .015" thick.

Packing Options

Packing Type	Features	Maximum Temperature
Low-Temp Elastomeric	Max Press & Vacuum	200° F.
High-Temp Elastomeric	Max Press & Vacuum	500° F.
Low-Temp Fiber	Economical	180° F.
High-Temp Fiber	Elevated Temperature	1000° F.
Metal	Extreme Temperature	800° - 1200° F.

T-REX™ (Roughbore) Hose Specifications

Inside Dia. (in.)	RX 15 _____ (GS,SS,16,20)		RX 18 _____ (GS,SS,16,20)		RX 25 _____ (GS,SS,20)	
	Weight per Foot (lbs.)	Min. Bend Radius (in.)	Weight per Foot (lbs.)	Min. Bend Radius (in.)	Weight per Foot (lbs.)	Min. Bend Radius (in.)
1.5	0.7	6	0.9	6		
2	1.0	8	1.1	8		
2.5	1.2	10	1.4	10		
3	1.4	12	1.6	12	2.5	13
3.5	1.6	14	1.9	14	2.8	15
4	1.8	16	2.2	16	3.2	17
4.5	2.0	17	2.4	17	3.6	19
5	2.2	19	2.7	19	4.0	21
6	2.7	23	3.2	23	4.7	25
7	3.1	27	3.7	27	5.5	29
8	3.5	30	4.2	30	6.2	33
9	3.9	34	4.7	34	7.0	37
10	4.4	38	5.2	38	7.7	41
11			5.7	42	8.5	45
12			6.2	45	9.3	49
13			6.7	49	10.0	53
14			7.2	53	10.8	56
15			7.7	56	11.5	60
16			8.2	60	12.3	64

Minimum bend radius is measured from the centerline of the hose. • T-Rex is sold in a relaxed state (see page 10 for explanation of "relaxed state"). For packed hose add 10% to both weight per foot and minimum bend radius.

ULTRAFLEX (Standard Smoothbore Interlocked)

ULTRAFLEX (Smoothbore) is constructed from two strips of metal that form a durable armored hose and a smooth, abrasion-resistant metal liner. The liner protects the product being conveyed from damage caused by a rough interior. A directional arrow on the hose indicates flow direction for optimum performance.

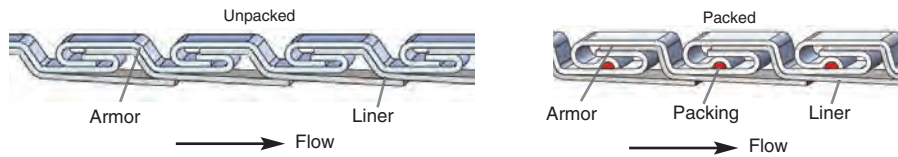

ULTRAFLEX Features

- Balanced interlocked construction
- Durability
- Strength
- Flexibility
- Service life
- Smooth interior resists abrasion and material build-up
- Rugged construction is able to handle everything from powder to pebbles

ULTRAFLEX Applications

- Bulk transfer of plastic pellets, grain, wood chips, and other abrasive media
- Loading and unloading trailers and rail cars

ULTRAFLEX Part Numbers

UF Armor Material Armor Thickness Liner Material

Armor Materials Codes	Armor Thickness Codes	Liner Materials Codes
A - Aluminum	15 - Light Weight	S - Stainless Steel
G - Galvanized Steel	18 - Medium Weight	C - Carbon Steel
S - T304 Stainless Steel	20 - Med. Wt. Aluminum	H - Heavy Weight
6 - T316 Stainless Steel	25 - Heavy Weight	Stainless Steel
2 - T201 Stainless Steel		4 - Magnetic Liner*

Example: UFS15S has an armor made of T304 stainless steel strip .015" thick, and a stainless steel liner.

Packing Options

Packing Type	Features	Maximum Temperature
Low-Temp Elastomeric	Max Press & Vacuum	200° F.
High-Temp Elastomeric	Max Press & Vacuum	500° F.
Low-Temp Fiber	Economical	180° F.
High-Temp Fiber	Elevated Temperature	1000° F.
Metal	Extreme Temperature	800° - 1200° F.

ULTRAFLEX (Smoothbore) Hose Specifications

Inside Dia. (in.)	UF ____ 15 ____ (G,S,6,2) (S,C,4)		UF ____ 18 ____ (G,S,6,2) (S,C,4)		UFS18S25***		UF ____ 25 ____ (G,S,2) (S,C,4)		UF ____ 25 H** (G,S,2)		UFA20S	
	Weight per Foot (lbs.)	Min. Bend Radius (in.)	Weight per Foot (lbs.)	Min. Bend Radius (in.)	Weight per Foot (lbs.)	Min. Bend Radius (in.)	Weight per Foot (lbs.)	Min. Bend Radius (in.)	Weight per Foot (lbs.)	Min. Bend Radius (in.)	Weight per Foot (lbs.)	Min. Bend Radius (in.)
1.5	1.2	7	1.3	8								
2	1.6	9	1.7	10								
2.5	1.9	11	2.2	12								
3	2.3	13	2.6	14			3.2	18				
3.5	2.6	15	3.0	16			3.7	21				
4	3.0	17	3.4	18	4.1	23	4.2	23	4.4	23	2.1	23
4.5	3.4	19	3.8	21	4.5	26	4.7	26	5.0	26	2.3	26
5	3.7	21	4.2	23	5.0	29	5.2	29	5.5	29	2.6	29
6	4.5	25	5.0	27	6.0	34	6.2	34	6.7	34	3.1	34
7	5.2	29	5.8	32	6.9	40	7.2	40	7.8	40	3.6	40
8	5.9	33	6.6	36	7.9	45	8.2	45	8.9	45	4.1	45
9	6.6	37	7.4	40	8.8	51	9.2	51	10.0	51	4.6	51
10	7.4	40	8.2	45	9.7	56	10.2	56	11.1	56	5.1	56
11			9.0	49	10.7	62	11.2	62				
12			9.8	53	11.7	67	12.2	67				
13			10.6	58	12.7	73	13.2	73				
14			11.4	62	13.6	78	14.2	78				
15			12.2	66	14.6	84	15.2	84				
16			13.1	71	15.5	89	16.2	89				

* Magnetic liner available on UF 15 or 18 series only.

** UF25H series is not available with packings.

***UFS18S25 is constructed with a stainless steel .018 armor and a .025 stainless liner

• Other diameters are available upon request. • For packed hose add 10% to both weight per foot and minimum bend radius. • Minimum bend radius is measured from the centerline of the hose. • Smoothbore hose is sold in a relaxed state (see page 10 for explanation of "relaxed state").

T-REX SB™ is Hose Master's torque-resistant smoothbore metal hose with enhanced sealability. T-Rex SB™ provides resistance to twisting, unwinding, and metal strip flare-up when cut.

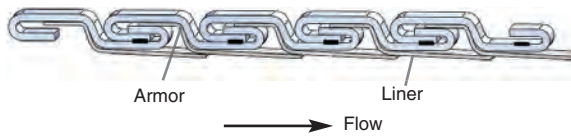

T-REX SB™ Features

- Torque-resistant
- Leak-resistant
- Same great flexibility as standard smoothbore product

T-REX SB™ Applications

- Dry bulk pneumatic conveying
- Material handling
- Pellet transfer
- Bulk unloading

T-REX SB™ (Smoothbore) Part Numbers

RX [Armor Material](#) [Armor Thickness](#) [Liner Material](#)

[Armor Material Codes](#)

G - Galvanized Steel
S - T304 Stainless Steel
6 - T316 Stainless Steel
2 - T201 Stainless Steel

[Armor Thickness Codes](#)

15 - Light Wt
18 - Medium Wt

[Liner Material Codes](#)

S - Stainless Steel
C - Carbon Steel
4 - Magnetic Liner

Example: RXS15S has an armor made of T304 stainless steel strip .015" thick, and a stainless steel liner

T-REX SB™ (Smoothbore) Hose Specifications

Inside Diameter (in.)	RX ____ 15 ____ (G,S,6,2) (S,C,4)		RX ____ 18 ____ (G,S,6,2) (S,C,4)		RXS18S25*	
	Weight per Foot (lbs.)	Min. Bend Radius (in.)	Weight per Foot (lbs.)	Min. Bend Radius (in.)	Weight per Foot (lbs.)	Min. Bend Radius (in.)
4	3.0	17	3.4	18	4.1	23
4.5	3.4	19	3.8	21	4.5	26
5	3.7	21	4.2	23	5.0	29
6	4.5	25	5.0	27	6.0	34
7	5.2	29	5.8	32	6.9	40
8	5.9	33	6.6	36	7.9	45
9	6.6	37	7.4	40	8.8	51
10	7.4	40	8.2	45	9.7	56
11			9.0	49	10.7	62
12			9.8	53	11.7	67
13			10.6	58	12.7	73
14			11.4	62	13.6	78
15			12.2	66	14.6	84
16			13.1	71	15.5	89

Minimum bend radius is measured from the centerline of the hose.

T-Rex is sold in a relaxed state (see page 10 for explanation of "relaxed state").

*RXS18S25 is constructed with a stainless steel .018 armor and a .025 stainless liner

FLOPPYGUARD™ (Floppy Interlocked)

FLOPPYGUARD™ (Interlocked) is Hose Master's line of floppy interlocked metal hose. Constructed from T304 or T316 stainless steel, this product offers flexibility, strength, durability, and crush resistance. FloppyGuard™ is available in sizes from 3/16" - 12" ID.

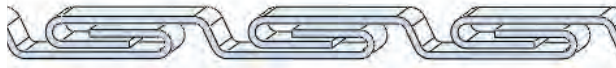

FLOPPYGUARD™ Features

- Flexibility
- Abrasion-resistant
- Crush-resistant
- Chemical-resistant
- Ultrasonically cleaned (up to 2" ID)

FLOPPYGUARD™ Applications

- Flexible, durable guard for wire, cable, or tubing
- Casing for fiber optic cables
- Internal and external protection of other hoses
- Air and fume handling, exhaust ducting, and dust collection systems

FLOPPYGUARD™ (Interlocked) Part Numbers SBxx [Material](#) xxxx

Material Codes

SS - T304 Stainless Steel
16 - T316 Stainless Steel
GS - Galvanized Steel*

FLOPPYGUARD™ (Interlocked) Hose Specifications

Nominal Inside Diameter (in.)	Part Number	Standard Material Thickness**	Minimum Bend Radius (in.)	Weight Per Foot (lbs.)
3/16	SB08_0018	.008	1.1	0.05
1/4	SB08_0025	.008	1.4	0.05
5/16	SB08_0031	.008	1.7	0.06
3/8	SB10_0037	.010	2.2	0.11
7/16	SB10_0043	.010	2.5	0.12
1/2	SB12_0050	.012	2.8	0.17
9/16	SB12_0056	.012	3.5	0.19
5/8	SB12_0062	.012	3.8	0.21
3/4	SB12_0075	.012	4.9	0.27
7/8	SB12_0087	.012	5.7	0.29
1	SB12_0100	.012	6.5	0.31
1 1/8	SB12_0112	.012	7.1	0.38
1 1/4	SB12_0125	.012	7.7	0.41
1 3/8	SB12_0137	.012	8.3	0.47
1 1/2	SB12_0150	.012	8.8	0.51
1 5/8	SB12_0162	.012	9.1	0.53
1 3/4	SB12_0175	.012	9.4	0.55
1 7/8	SB12_0187	.012	9.7	0.59
2	SB12_0200	.012	9.9	0.70
3	SB15_0300	.015	12	1.40
4	SB15_0400	.015	16	1.90
5	SB15_0500	.015	19	2.20
6	SB15_0600	.015	23	2.70
7	SB15_0700	.015	27	3.10
8	SB15_0800	.015	30	3.50
10	SB15_1000	.015	38	4.40
12	SB18_1200	.018	45	6.20

*Galvanized Steel is only offered in sizes 3 inch and above.

**Fractional sizes and other material gauges may be available. Please consult factory.

800-221-2319 • www.hosemaster.com

FLOPPYGUARD SQ™ (Squarelocked) is Hose Master's line of squarelocked stripwound hose. It can be used in a wide variety of applications where the added flexibility of squarelocked hose is required. It is used as shielding on electrical wiring and fiber optic cable. FloppyGuard SQ™ is available in sizes ranging from 5/32" - 1/2" ID.



FLOPPYGUARD SQ™ Features

- Flexibility
- Abrasion-resistant
- Crush-resistant
- Chemical-resistant
- Ultrasonically cleaned

FLOPPYGUARD SQ™ Applications

- Flexible, durable guard for wire, cable, or tubing
- Fiber optic cables
- Internal and external protection of other hoses

FLOPPYGUARD SQ™ (Squarelocked)

FLOPPYGUARD SQ™ is made from T304 stainless steel .010 thick.

FLOPPYGUARD SQ™ (Squarelocked) Hose Specifications

Nominal Inside Diameter (in.)	Part Number	Minimum Bend Radius (in.)	Weight Per Foot (lbs.)
5/32	SQ10SS0015	0.6	0.03
3/16	SQ10SS0018	0.7	0.04
7/32	SQ10SS0021	0.8	0.04
1/4	SQ10SS0025	0.9	0.05
9/32	SQ10SS0038	0.9	0.05
5/16	SQ10SS0031	1.1	0.06
11/32	SQ10SS0034	1.1	0.06
3/8	SQ10SS0037	1.1	0.06
13/32	SQ10SS0040	1.2	0.07
7/16	SQ10SS0043	1.2	0.08
15/32	SQ10SS0047	1.2	0.08
1/2	SQ10SS0050	1.3	0.09

* Other material gauges may be available. Please consult factory.

POLYGONAL HOSE

POLY-REX HOSE

POLY-REX is Hose Master's line of polygonal interlocked metal hose. Constructed from T304, T316, T201, or Galvanized steel in a variety of different thicknesses, this product offers the most robust resistance to torsional stress, without sacrificing flexibility.

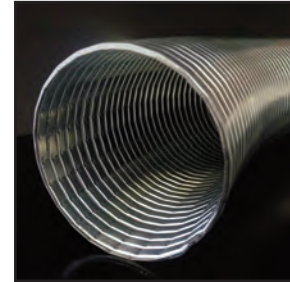
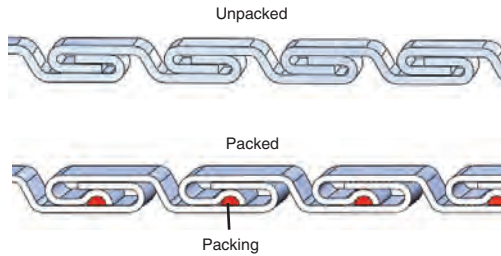

POLY-REX Features

- Highly-resistant to torque
- Durable, balanced interlocked construction
- Bi-directional construction offers error-free connection of hose inlet / outlet to existing system

POLY-REX Applications

- Dry bulk pneumatic conveying
- Material handling
- Pellet transfer
- Bulk unloading

POLY-REX (Roughbore) Part Numbers

PX Thickness Material

Thickness Codes

- 15 - Light Weight
- 18 - Medium Weight
- 25 - Heavy Weight

Material Codes

- GS - Galvanized Steel
- SS - T304 Stainless Steel
- 16 - T316 Stainless Steel
- 20 - T201 Stainless Steel

Example: PX15SS is made from T304 stainless steel strip .015" thick.

Packing Options*

Packing Type	Features	Maximum Temperature
Low-Temp Elastomeric	Max Press & Vacuum	200° F.
High-Temp Elastomeric	Max Press & Vacuum	500° F.
Low-Temp Fiber	Economical	180° F.
High-Temp Fiber	Elevated Temperature	1000° F.
Metal	Extreme Temperature	800° - 1200° F.

POLY-REX (Roughbore) Hose Specifications

Inside Dia. (in.)	PX 15 _____ (GS,SS,16,20)		PX18 _____ (GS,SS,16,20)		PX25 _____ (GS,SS,20)	
	Weight per foot (lbs.)	Min. Bend Radius (in.)	Weight per foot (lbs.)	Min. Bend Radius (in.)	Weight per foot (lbs.)	Min. Bend Radius (in.)
4	1.8	16.5	2.2	18	3.2	20
5	2.2	21	2.7	23	4.0	25
6	2.7	25	3.2	26	4.7	29.5
7	3.1	29.5	3.7	31.5	5.5	34.5
8	3.5	33.5	4.2	35.5	6.2	39

*For packed hose add 20% to minimum bend radius

TAR & ASPHALT HOSE

TAR & ASPHALT (Roughbore) is Hose Master's heavy-weight interlocked metal hose. Constructed from a single strip of galvanized steel with Hose Master's proprietary packing, this hose is used for transferring high-temperature, viscous fluids. Tar & Asphalt hose is leak-resistant and handles maximum suction. It is design-tested to 100 psi and has a temperature range of -40° F. to 500° F.



TAR & ASPHALT

Part Numbers TA [Thickness](#) [Material](#)

[Thickness Code](#)

25 - Heavy Weight
30 - Extra Heavy Weight

[Material Code](#)

SS - 201 Stainless Steel
GS - Galvanized Steel

TAR & ASPHALT (Roughbore) Hose Specifications

Inside Diameter (In.)	Minimum Bend Radius (in.)	25-Heavy Weight, 201 Stainless Steel Weight per Foot (lbs.)	30-Extra Heavy Weight, Galvanized Steel Weight per Foot (lbs.)
1.5	9	1.5	1.8
2	12	1.9	2.2
2.5	15	2.4	2.8
3	17	2.7	3.2
4	22	3.6	4.2

25 - Heavy Weight Strip is only available in 201 Stainless Steel • 30 - Extra Heavy Weight Strip is only available in Galvanized Steel
Other diameters are available upon request. • Minimum bend radius is measured from the centerline of the hose.

TAR & ASPHALT FITTINGS

Heavy-duty, reusable rigid male or female swivel fittings are available upon request. These specialized fittings are packed onto the hose ends, eliminating the need for welding that could burn the sealant packing within the hose.



Tar & Asphalt Male and Female Connections

Alloys	Malleable Iron
Size Range	1 1/2" thru 3"
Sch.	N/A



Tar & Asphalt Shank Male

Alloys	Malleable Iron
Size Range	1 1/2" thru 4"
Sch.	40

Selecting the proper fittings for an application is largely determined by the mating fittings to which the hose assembly will be attached. Once the mating fittings have been identified, the hose fittings should complement the mating fittings in type, size, and alloy. Even though the selection of hose fittings is determined by the mating fittings, it is a good idea to confirm that the fittings used are appropriate for the application. Ensure that the fittings are chemically compatible with the conditions in which the hose will be installed and used.

The following pages cover a sampling of commonly used fittings for stripwound metal hose. For items not listed, please contact Hose Master's Inside Sales Department.



Male Pipe Nipple

Alloys	T304 & T316 Stainless Steel, Carbon Steel, and Aluminum
Size Range	1.5" - 8"
Sch.	40 & 80

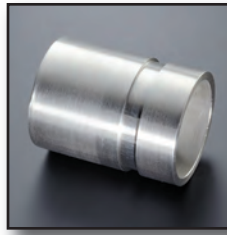

Grooved-End

Alloys	T304 & T316 Stainless Steel, Carbon Steel
Size Range	1.5" - 8"
Sch.	40



Slip-on Flange

Alloys	T304 & T316 Stainless Steel, Carbon Steel
Size Range	1.5" - 12"
Class	150 & 300



Plate Flange

Alloys	T304 & T316 Stainless Steel, Carbon Steel
Size Range	1.5" - 14"
Class	150# drilling



C-Stub with Floating Flange

Alloys	T304 & T316 Stainless Steel
Size Range	1.5" - 10"
Sch.	10



Part A and Part D (Cam-Lock)

Alloys	T316 Stainless Steel, Aluminum
Size Range	1.5" - 10"
Sch.	N/A



Swivel Part D Coupler (Reusable)

Alloys	Aluminum Body with Stainless Steel Insert
Size Range	4" - 6"
Sch.	N/A

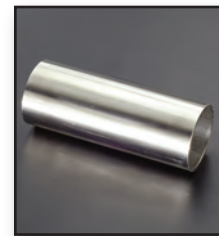

Tube End

Alloys	T304 & T316 Stainless Steel, Carbon Steel, and Aluminum
Size Range	1.5" - 8"
Wall Thick.	Various

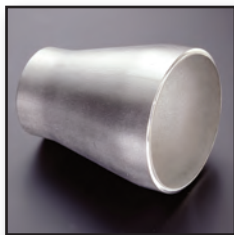

Reducer

Alloys	T304 & T316 Stainless Steel, Carbon Steel
Size Range	1.5" - 6"
Sch.	10 & 40 (Carbon Steel)

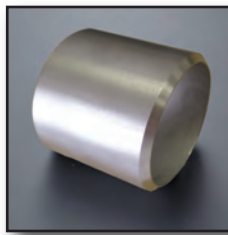

Beveled Pipe End

Alloys	T304 & T316 Stainless Steel, Carbon Steel, and Aluminum
Size Range	1.5" - 8"
Sch.	Various



NPSM Female or Male

Alloys	T304 Stainless Steel, Carbon Steel
Size Range	1.5" - 6"
Class	N/A



Compensator

Alloys	Urethane
Size Range	3" - 6"
Class	N/A

FLOW-TITE FITTINGS

Flow-Tite is an interlocked metal hose assembly that features a patented fitting system designed for leak resistance and smooth product flow. The fittings are internally expanded to provide an extremely smooth transition from the hose to the fitting and incorporate an internal silicone sealant for leak-free, positive pressure, or vacuum service (*refer to page 13 for fabrication description*).

Flow-Tite has a weld-free design that ensures smooth flow while minimizing leakage. Because of their ability to handle higher temperatures (up to 400° F) Flow-Tite assemblies can replace polyurethane and UHMW products. Flow-Tite is available in Ultraflex smoothbore or Interflex roughbore constructions.



Male Pipe Nipple

Alloys	T304 & T316 Stainless Steel, Carbon Steel, and Aluminum
Size Range	4" - 6"
Sch.	40

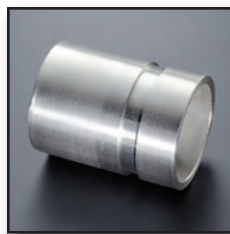

Grooved-End

Alloys	T304 & T316 Stainless Steel, Carbon Steel
Size Range	4" - 6"
Sch.	40

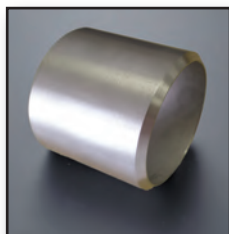

Weld End

Alloys	T304 & T316 Stainless Steel, Carbon Steel, and Aluminum
Size Range	4" - 6"
Sch.	40

Various States of Hose Length

Interlocked metal hose can be Compressed (Figure 1) and Extended (Figure 3), and it is this ability that allows the hose to bend. The Relaxed Length (R) is defined as the average between the Extended Length (E) and the Compressed Length (C) of the hose (Figure 2), and is calculated as $R=1/2 (C+E)$. When interlocked hose is bent as far as it can go, the outside surface of the hose is in the Extended state, while the inside surface is in the Compressed state.

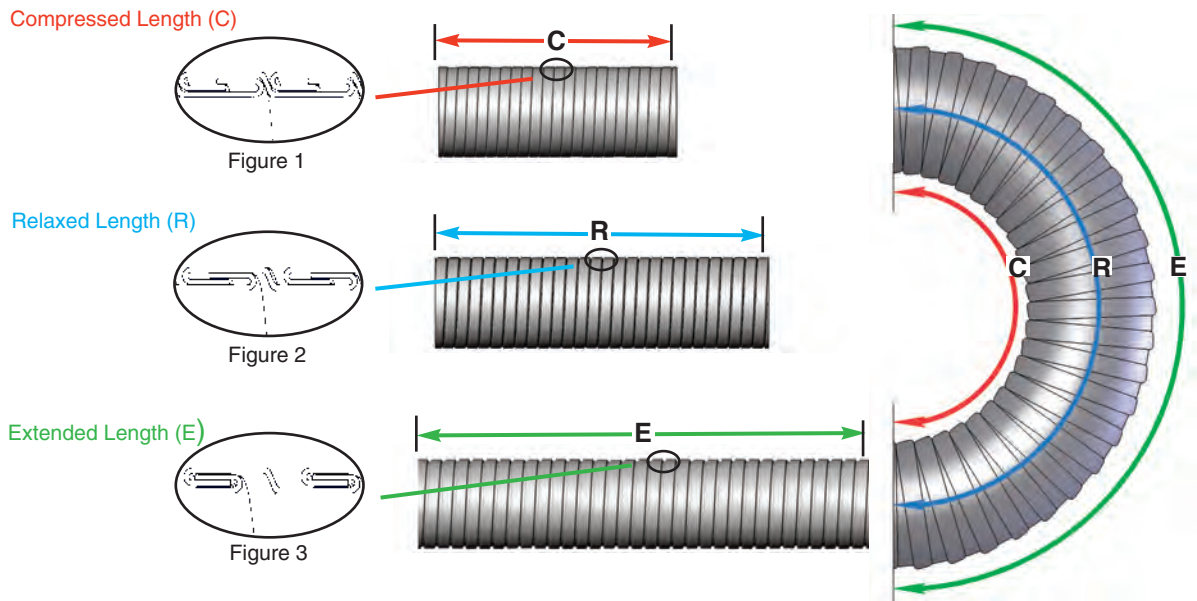

Measuring Various Hose States

The Relaxation Factor is defined as Extended Length (E) divided by Relaxed Length (R) and is used to facilitate ordering interlocked hose. Hose Master can provide the Relaxation Factor for each of our interlocked hose products.

Interlocked metal hose is generally priced and defined in its extended state. Frequently, the hose designer thinks in terms of the relaxed state. This is especially true when using smoothbore hose, packed hose, and calculating assembly length. In these cases, the purchaser must define the state (relaxed) when placing an order, OR multiply the desired (relaxed) length by its Relaxation Factor to order it as an extended length.

Example: For a hose with a relaxation factor of 1.12

To obtain a 20-foot relaxed length of hose, it can be ordered as 22.4 feet of extended product (20' x 1.12). Additionally, if this extended length of hose weighs 3 lbs. per foot, and costs \$4.00 per foot, then in the relaxed state it will weigh 3.36 lbs. per foot (3 lbs. per foot x 1.12) and it will cost \$4.48 per foot (\$4.00 per foot x 1.12).

Interlocked metal hose is used in a variety of applications. Just as the hose, fittings, and other assembly parts must be tailored to suit the demands of the service, so must the methods of joining these components. Hose Master has developed specialized fabrication procedures to ensure the integrity and serviceability of metal hose assemblies in even the most extreme applications.

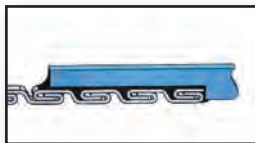

Epoxy

Fittings may be attached to interlocked hose using a two-part epoxy. An epoxied fitting-to-hose connection, made with properly prepared fittings, can be as strong as or stronger than the hose itself at service temperatures up to 200°F. Epoxy is recommended for packed interlocked hose to avoid damaging the packing material. Epoxy also affords a convenient method for field attachment of a variety of fittings to interlocked hose.

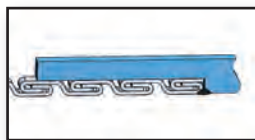

Welding/Brazing

Welding provides the strongest possible connection between the hose and fittings. Whenever possible, the weld is made on the interior hose-to-fitting joint, in order to provide a smooth surface over which the media flows. Welding is generally not recommended for packed interlocked hose, as the packing may be damaged by the high welding temperature.



ID/OD Welding

Welding the interior hose-to-fitting joint provides for a smooth transition, preventing product from becoming damaged. Also, welding on the outside of the hose prevents exterior contamination from entering the crevice and provides additional strength.



Mechanical Attachment (Tar & Asphalt)

Certain high-temperature applications, like tar and asphalt service, require a fitting that actually threads and locks onto the hose corrugations. A high-temperature packing is used to seal against leakage. These fittings are leak-tight up to 500° F and are easily field attached.



Flow-Tite

The internally expanded design eliminates the need for welded or epoxied ends, while providing a leak-free, full-flow connection. These fittings are ideal for use with packed stripwound hose in dense-phase pneumatic conveying systems, or whenever a smooth assembly interior is required.



Square Cutting

The stripwound profile is helical. When it is cut by traditional methods, the hose end will also be helical, creating a gap between the fitting and the end of the hose. This gap can cause the fittings to separate from the hose during use. Square cutting the hose ends ensures that the hose and the fitting are flush.

Stripwound hose assemblies often require special accessories or components. Accessories may be used to improve performance or to make the assembly easier to use or identify. Other accessories are available upon request, please contact Hose Master's Inside Sales Department for details.

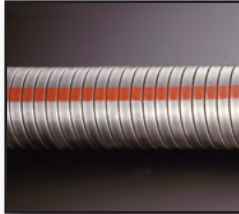

Lay Line

A straight painted line can be applied to interlocked hose along its entire length. The lay line serves to give clear warning to the user if the hose is being torqued or twisted in service. Monitoring torsion or twisting of an assembly can significantly increase the service life of the hose.

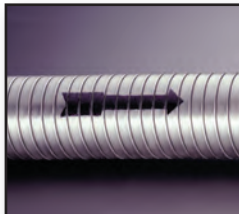

Flow Arrows

Smoothbore interlocked hose is uni-directional. Media flowing in the wrong direction can easily cause damage both to the hose and to abrasion-sensitive media, such as plastic pellets. Flow arrows are painted on all smoothbore hose to indicate the correct flow direction. In specific high-velocity applications, the flow direction may also become a factor in roughbore interlocked hose. Flow arrows can be provided on roughbore hose upon request.



Braid

For elevated working pressures, or for critical safety situations, a stainless steel braid can be installed and welded over a stripwound hose assembly. The braid serves to prevent the hose from overextending, and protects the hose wall from being damaged.

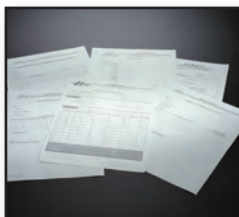

Certifications

Standard written certifications for materials or inspections can be supplied for stripwound hose or assemblies. Certifications of conformance to specific customer requirements and PMI (Positive Material Identification) are also available upon request.

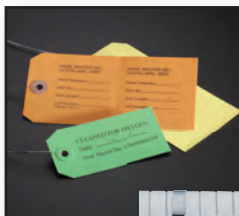

Tagging

A variety of tags (metal, plastic, or cardboard) are readily available to record hose identification, service information, or any customer-specific information.



Manufacturing, Fabricating, and Stocking Facilities



Large inventories and fabricating resources enable us to respond quickly to customer demands.

Testing and Certifications

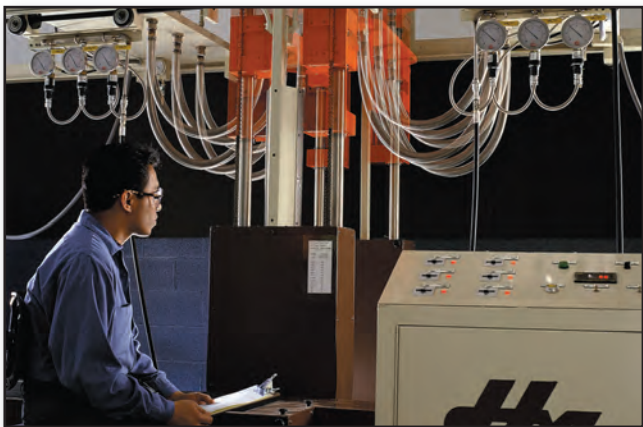

PED
Pressure
Equipment
Directive



ASME IX
Certified Welders



Stripwound Metal Hose and Assemblies



Corrugated Metal Hose and Assemblies



Metal Bellows and Expansion Joints





HOSE MASTER

1233 East 222nd Street • Cleveland, Ohio 44117
(800) 221-2319 • Fax: (216) 481-7557 • www.hosemaster.com
Cleveland • Houston • Atlanta • Reno

ISO 9001
Registered Quality System



Copyright © 2015 by Hose Master, LLC All rights reserved